

Dear customer:

Thank you for choosing TGB ATV, our ATV is manufactured under strict quality control system. The warranty document sent to dealers guarantees all written items. Give that you follow the maintenance procedure by using original parts and riding normally, we readily assent to repair or change them.

This warranty excludes:

1. Using unspecified engine oil.
2. Improper maintenance or repairs.
3. Using non-original or modified accessories and parts.
4. Operating lack of conformity to manual.
5. Normal wear and tear seat, spark plug, bulbs, wire filters, battery, brake, belt, chain, sprockets, tires...etc.

Before you operate your new ATV, **TGB** recommends these important points:

- ◆ Read your Owner's Manual
- ◆ A child under 16 years old should not operate an ATV when engine size greater than 90 cc.
- ◆ Take the training course before your operate ATV, ask your dealer for information.

NAME: \_\_\_\_\_

ADDRESS: \_\_\_\_\_  
\_\_\_\_\_

TELEPHONE: \_\_\_\_\_

PURCHASE DATE: \_\_\_\_\_

ATV MODEL: \_\_\_\_\_

FRAME NO. \_\_\_\_\_

ENGINE NUMBER: \_\_\_\_\_

KEY NUMBER: \_\_\_\_\_

## INTRODUCTION

Read this manual carefully before operating this vehicle. This manual should stay with vehicle if it is sold.

This manual will provide you with a good basic understanding of the features and operation of this ATV. This manual includes important safety information. It provides information about special techniques and skills necessary to ride the ATV. It also includes basic maintenance and inspection procedures. If you have any questions regarding the operation or maintenance of your ATV, please consult a **TGB** dealer.

### AN IMPORTANT SAFETY MESSAGE:

- ◆ Read this manual carefully and completely before operating your ATV. Make sure you understand all instructions.
- ◆ Pay attention to the warning and notice labels on the ATV.
- ◆ Never operate an ATV without proper training or instruction. For relative training course, please consult a **TGB** dealer.
- ◆ This ATV should not be ridden by anyone under 16 years of age.

## IMPORTANCE MANNUAL INFORMATION

FAILURE TO FOLLOW THE WARNINGS CONTAINED IN THIS MANUAL CAN RESULT IN SERIOUS INJURY OR DEATH.

Particularly important information is distinguished in this manual by the following notations:



This is safety alert symbol. It is used to alert you to potential personal injury hazards.

Obey all safety messages that follow this symbol to avoid possible injury or death.

**WARNING!** Indicates a hazardous situation that, if not avoided, could result in death or serious injury.

**CAUTION!** Indicates special precautions that must be taken to avoid damage to the vehicle or other property.

**NOTES** Provides key information to make procedures easier or clearer.

\* Product and specifications are subject to change without notice.

## IMPORTANT NOTICE

This ATV is designed and manufactured for off-road. It is illegal and unsafe to operate this ATV on any public street, road or highway.

This ATV complies with all applicable off-road noise level and regulations in effect at the time of manufacture.

Please check your local riding laws and regulations before operating this ATV.

## CONTENTS

<b>SPECIFICATIONS</b> .....	<b>4</b>
<b>IMPORTANT IDENTIFICATION NUMBERS</b> .....	<b>6</b>
<b>LOCATION OF THE WARNING AND SPECIFICATION LABEL</b> .....	<b>7</b>
<b>SAFETY INFORMATION</b> .....	<b>12</b>
<b>PRE-OPERATION CHECKS</b> .....	<b>15</b>
<b>DESCRIPTION</b> .....	<b>17</b>
<b>INSTRUMENT AND CONTROL FUNCTION</b> .....	<b>18</b>
<b>1. Ignition Switch Function/Position</b> .....	<b>18</b>
<b>2. Signs and Function</b> .....	<b>18</b>
<b>3. Front Brake Lever</b> .....	<b>18</b>
<b>4. Rear Brake Lever and Brake Pedal</b> .....	<b>19</b>
<b>5. Shift Lever</b> .....	<b>20</b>
<b>6. Drive Mode Select</b> .....	<b>20</b>
<b>7. Tires</b> .....	<b>22</b>
<b>8. Coolant</b> .....	<b>23</b>
<b>9. Steering Lock</b> .....	<b>25</b>
<b>10. Speedometer</b> .....	<b>26</b>
<b>11. Spark Plug</b> .....	<b>30</b>
<b>12. Air Cleaner</b> .....	<b>30</b>
<b>13. Engine Oil and Oil Filter</b> .....	<b>30</b>
<b>14. Transmission Oil</b> .....	<b>32</b>
<b>15. Front Differential Gear Oil</b> .....	<b>33</b>
<b>16. Rear Differential Gear Oil</b> .....	<b>34</b>
<b>17. Seat</b> .....	<b>35</b>
<b>18. Fuel Tank</b> .....	<b>35</b>
<b>19. Storage Compartment</b> .....	<b>35</b>
<b>20. Fuse and Battery</b> .....	<b>36</b>
<b>21. Replacing a Headlight Bulb</b> .....	<b>38</b>
<b>22. Replacing The Tail/Brake Light Bulb</b> .....	<b>39</b>
<b>23. Auxiliary DC Jack</b> .....	<b>39</b>
<b>PRECAUTION OF ATV RIDING</b> .....	<b>41</b>
<b>PERIODIC MAINTENANCE</b> .....	<b>52</b>
<b>CLEANING AND STORAGE</b> .....	<b>55</b>
<b>TROUBLESHOOTING</b> .....	<b>57</b>
<b>MAINTENANCE RECORD</b> .....	<b>59</b>
<b>CONSUMER INFORMATION</b> .....	<b>61</b>

## SPECIFICATIONS

		EST		
Overall Length		2330		[mm]
Overall Width		1200		[mm]
Overall Height		1290	1288	[mm]
Wheel Base		1445		[mm]
Mass of vehicle in running order	Front	235		[kg]
	Rear	233		[kg]
	Total	468		[kg]
Mass of vehicle in running order, together with rider	Front	205		[kg]
	Rear	300		[kg]
	Total	543		[kg]
Type		4-Stroke Engine, V-Twin		
Installation and arrangement		Vertical, below center, incline		
Fuel Used		Above 92 unleaded		
Cycle/Cooling		4-stroke/Water cooled		
Cylinder	Bore	Ø92		[mm]
	Stroke	75		[mm]
	Number/Arrangement	Two Cylinder, V-type		
Displacement		997.1		[cc]
Compression Ratio		10.2:1		
Max. HP		15 / 4750		[kw/rpm]
Max. Torque		33.2 / 3000		[Nm/rpm]
Ignition		Transistorized Ignition		
Starting System		Electrical starter		
Air filtration		Sponge		
Suspension System	Front	Double A-Arm		
	Rear	Double A-Arm		
Tire Specifications	Front	26X8-14	25X8-12	
	Rear	26X10-14	25X10-12	
Rim		Aluminum / Steel		
Brake System	Front	Disk (Ø 230)	Disk (Ø 200)	[mm]
	Rear	Disk (Ø 210)	Disk (Ø 190)	[mm]
Performance	Max. Speed	72		km/hr
	Climb Ability	< 25		°
Reduction	Primary Reduction	Belt		
	Secondary Reduction	Gear / Shaft		

	Transmission	C.V.T., auto speed change	
Fuel capacity		23	[l]
Lubrication System		Forced circulation & splashing	
Engine oil	Engine oil	SAE 10 W/ 40	
	Capacity	2.3	[l]
Gear lubrication	Spec.	SAE 90#	
	Transmission	800	[ml]
	Front Diff.	350	[ml]
	Rear Diff.	500	[ml]
Exhaust Concentration	CO	< 4.83	[g/ km]
	HC	< 0.67	[g/ km]
	Nox	< 0.21	[g/ km]
Spark Plug		DENSO XU24EPR-U	
Battery		12/18	V/AH
Lamps	Front Lamps (HI/LO)	55x2 55x2	[W]
	Rear Lamps	2.2x2	[W]
	Daytime Running lamp	7x2	[W]
	Brake Lamps	2.2 × 2	[W]
	Turn Lamps	2.2 × 4	[W]

## IMPORTANT IDENTIFICATION NUMBERS

### 1. Frame Number:

Record chassis and engine number for future reference.

Number is located front right hand side of chassis as shown in (1)

### 2. Engine number is located front of the engine as shown in (2)

### 3. Manufacturer's DATA PLATE

The manufacturer's data plate is located front right hand side of chassis as shown in (3).

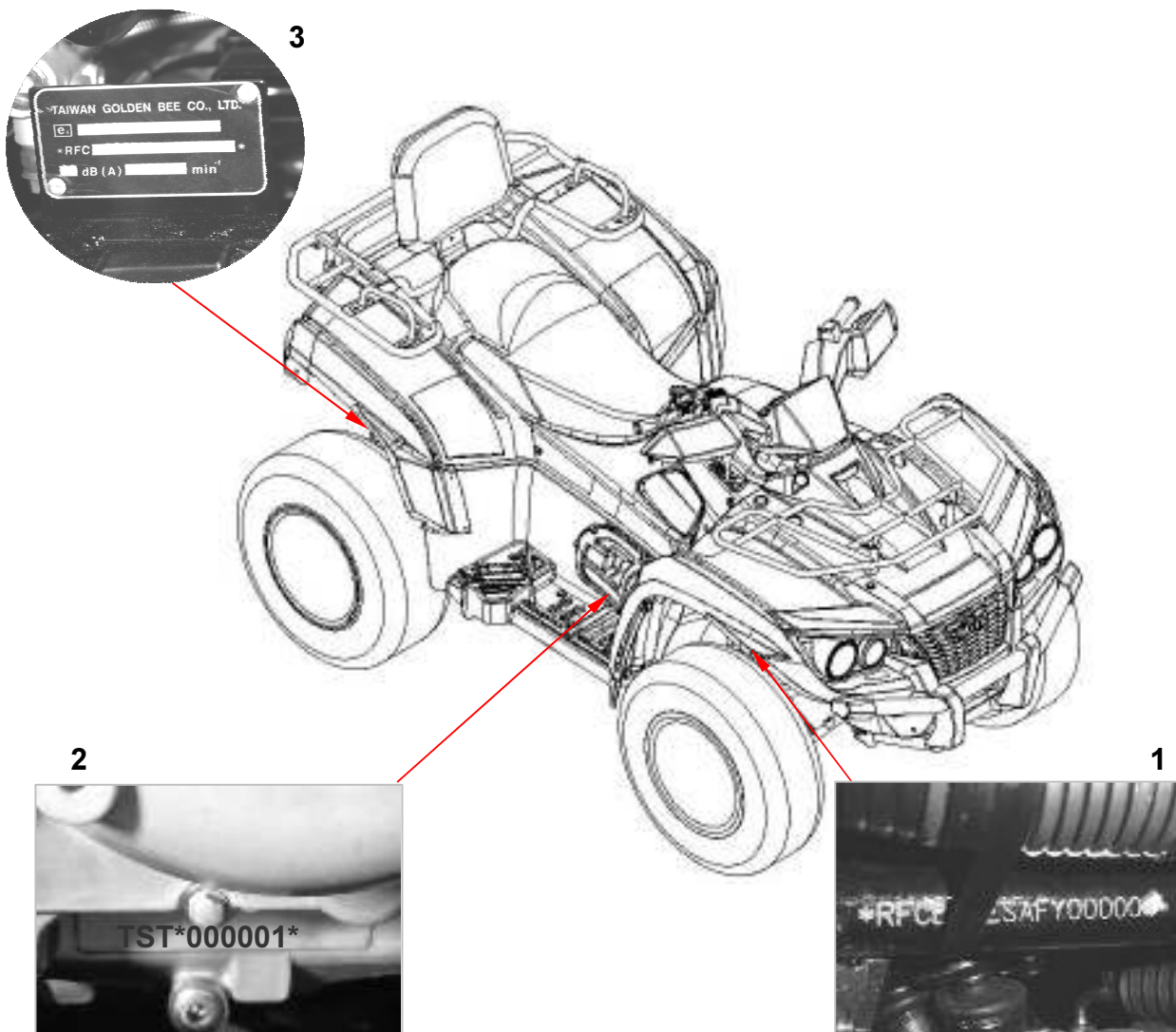

# LOCATION OF THE WARNING AND SPECIFICATION LABELS

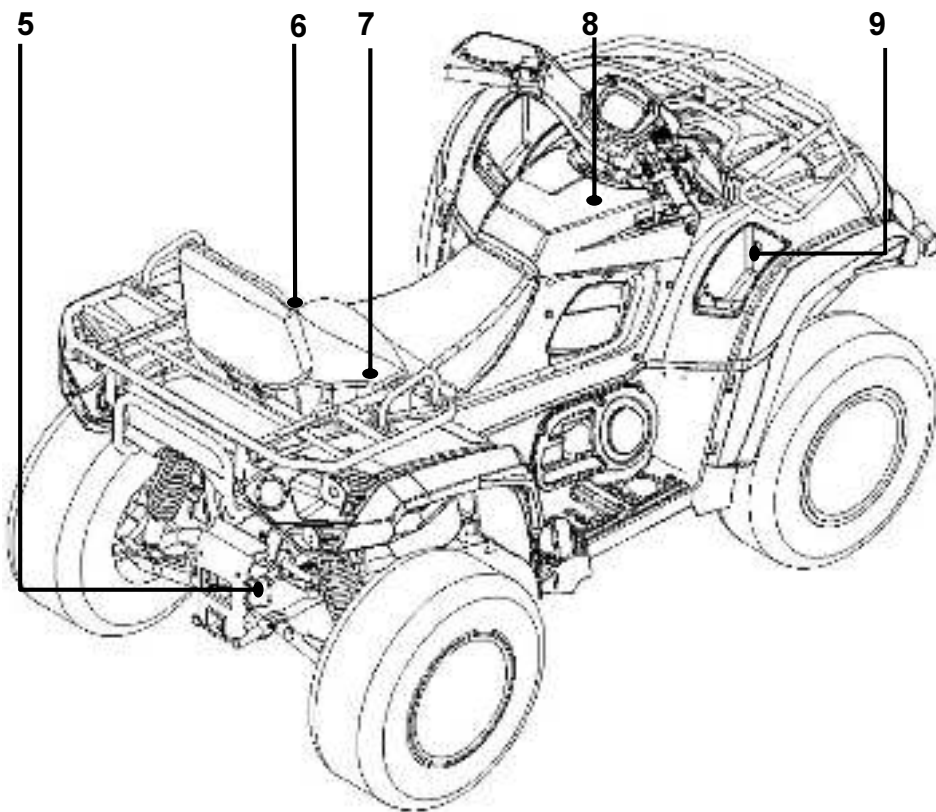
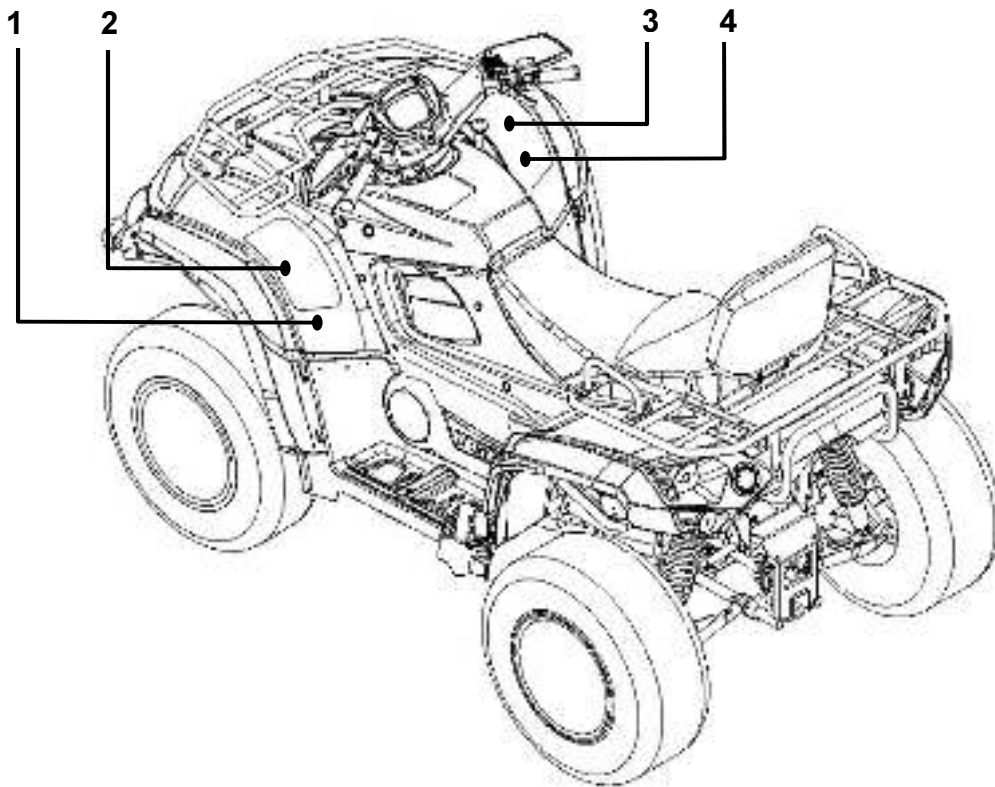

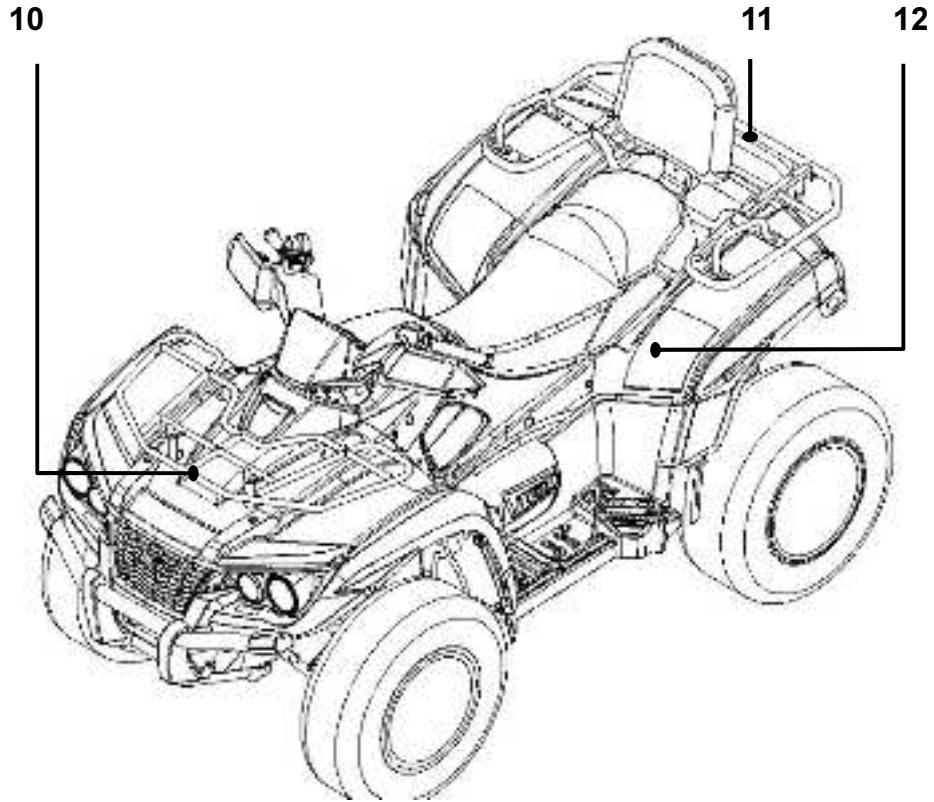

Read and understand all of the labels on your ATV. These labels contain important information for safe and proper operation.

Never remove any labels from your ATV. If a label becomes difficult to read or comes off, request a replacement label from your **TGB** dealer.

1

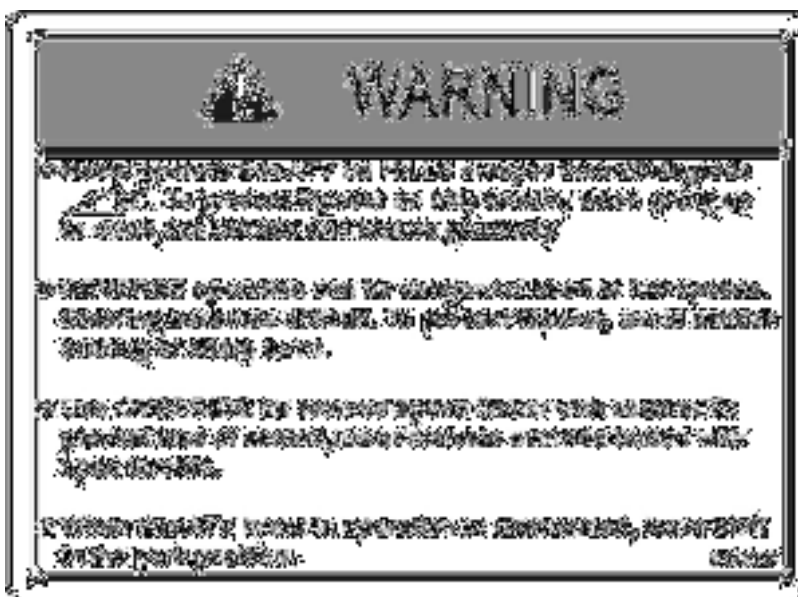

Riding safety notification





4

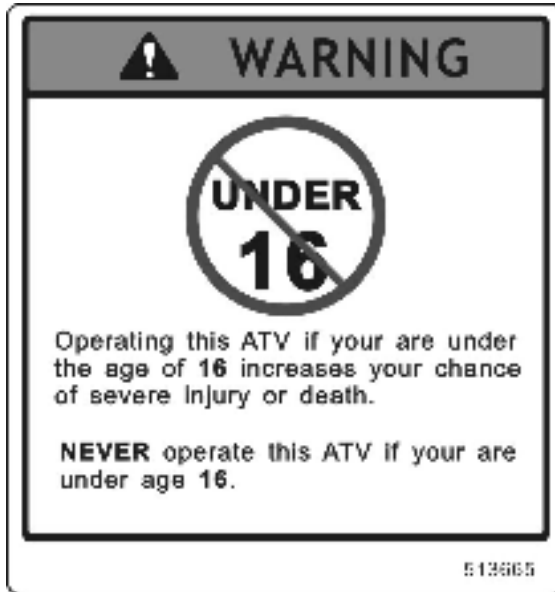

Age under 16 years old is prohibited

6

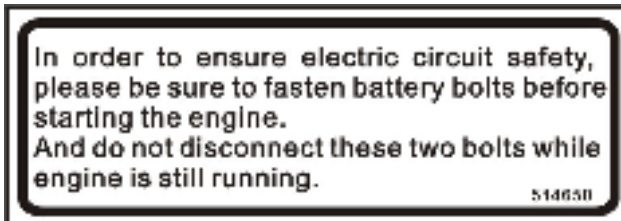

Battery should install and fasten properly

7

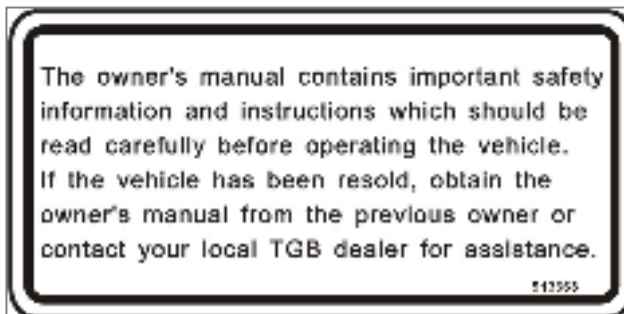

Read the Owner's Manual before operate the vehicle.

8



Operating the LOCK gear select, the speed should not exceed 16 KPH (10MPH).

9



Electrical accessories must not exceed 12 W rating 12V.

10

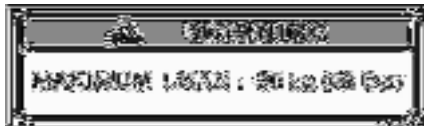

Front carrier maximum loading should not exceed 30 kg (66 lbs).

11



Rear carrier maximum loading should not exceed 50 kg (110 lbs).

12

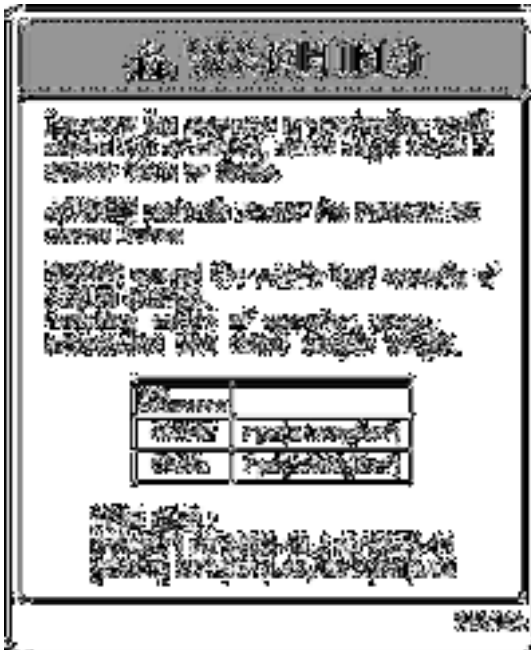

Tire size and pressure

## **SAFETY INFORMATION**

### **AN ATV IS NOT A TOY AND CAN BE HAZARDOUS TO OPERATE**

An ATV handles differently from other vehicles, including motorcycles and cars. A collision or rollover can occur quickly, even during routine maneuvers such as turning and riding on hills or over obstacles, if you fail to take proper precautions.

SEVERE INJURY OR DEATH can result if you do not follow these instructions:

- ◆ Read this manual and all labels carefully and follow the operating procedures described.
- ◆ Never operate an ATV without proper training or instruction. **TAKE A TRAINING COURSE**. Beginners should receive training from a certified instructor. Contact an authorized ATV dealer to find out about the training courses nearest you.
- ◆ Always follow the age recommendation:  
A child under 16 years old should never operate an ATV with engine size greater than 90 cc.
- ◆ **NEVER ALLOW A CHILD UNDER AGE 16 TO OPERATE AN ATV** without adult supervision, and never allow continued use of an ATV by a child if he or she does not have the abilities to operate it safely.
- ◆ Always avoid operating an ATV on any sidewalks, driveways, parking lots and streets.
- ◆ Never operate an ATV on any public street, road or highway, even dirt or gravel one.
- ◆ Never operate an ATV without wearing an approved motorcycle helmet that fits properly. You should also wear eye protection (goggles or face shield), gloves, boots, a long-sleeved shirt or a jacket and long pants.
- ◆ Never consume alcohol or drugs before or while operating this ATV.
- ◆ Never operate at speeds too fast for your skills or the riding conditions. Always go at a speed that is proper for the terrain, visibility, operating conditions and your experience.
- ◆ Never attempt wheels, jumps or other stunts.
- ◆ Always inspect your ATV each time you use it to make sure it is in safe operating condition. Always follow the inspection and maintenance procedures and schedules described in this manual.
- ◆ Always keep both hands on the handlebars and both feet on the footboards of the ATV during operation.
- ◆ Always go slowly and be extra careful when operating on unfamiliar terrain. Always be alert to changing terrain conditions when operating the ATV.
- ◆ Never operate on excessively rough, slippery or loose terrain until you have learned and practiced the skills necessary to control the ATV on such terrain, Always be especially cautious on these kinds of terrain.
- ◆ Always follow proper procedures for turning as described in this manual. Practice turning at low speeds before attempting to turn at faster speeds and never turns at excessive speeds.
- ◆ Never operate the ATV on hills too steep for the ATV or for your abilities. Practice on smaller hills before attempting larger hills.

- ◆ Always follow proper procedures for climbing hills as described in this manual. Check the terrain carefully before you start up any hill. Never climb hills with excessively slippery or loose surfaces. Shift your weight forward. Never open the throttle suddenly. Never go over the top of a hill at high speed.
- ◆ Always follow proper procedures for going down hills and for braking on hills as described in this manual. Check the terrain carefully before you start down any hill. Shift your weight backward. Never go down a hill at high speed. Avoid going down a hill at an angle that would cause the vehicle to lean sharply to one side. Go straight down the hill where possible.
- ◆ Always follow proper procedures for crossing the side of a hill as described in this manual. Avoid hills with excessively slippery or loose surfaces. Shift your weight to the uphill side of the ATV. Never attempt to turn the ATV around on any hill until you have mastered the turning technique described in this manual on level ground. Avoid crossing the side of steep hill if possible.
- ◆ Always use proper procedures if you stall or roll backwards when climbing a hill. To avoid stalling, use the proper gear range and maintain a steady speed when climbing a hill. If you stall or roll backwards, follow the special procedure for braking described in this manual. Dismount on the uphill side or to a side if pointed straight uphill. Turn the ATV around and remount, following the procedure described in this manual.
- ◆ Always check for obstacles before operating in a new area.
- ◆ Never attempt to operate over large obstacles, such as large rocks or fallen trees. Always follow proper procedures when operating over obstacles as described in this manual.
- ◆ Always be careful when skidding or sliding. Learn to safety control skidding or sliding by practicing at low speeds and on level, smooth terrain. On extremely slippery surfaces, such as ice, go slowly and be very cautious in order to reduce the chance of skidding or sliding out of control.
- ◆ Never operate an ATV in fast flowing water or in water deeper than that recommended in this manual. Remember that the wet brakes may have reduced stopping ability. Test your brakes after leaving water. If necessary, apply them several times to let friction dry out the linings.
- ◆ Always be sure there are no obstacles or people behind you when you operate in reverse. When it is safe to proceed in reverse, go slowly.
- ◆ Always use the size and type of tires specified in this manual.
- ◆ Always maintain proper tire pressure as described in this manual.
- ◆ Never modify an ATV through improper installation or use of accessories.
- ◆ Never exceed the stated load capacity for an ATV. Cargo should be properly distributed and securely attached. Reduce speed and follow instructions in this manual or carrying cargo or pulling a trailer. Allow greater distance for braking.

**WARNING!**

All engine exhaust contains carbon monoxide, a deadly gas. Carbon Monoxide is a colorless, odorless, tasteless gas, which may be present even if you do not see or smell any engine exhaust.

Avoid Carbon Monoxide Poisoning.

- ◆ Do not run engine indoors. Even if you try to ventilate engine exhaust with fans or open windows and doors, carbon monoxide can rapidly reach dangerous levels.
- ◆ Do not run engine in poorly ventilated or partially enclosed areas such as barns, garages or carports.
- ◆ Do not run engine outdoors where engine exhaust can be drawn into a building through opening such as window and doors.

## PRE-OPERATION CHECKS

Inspect your vehicle each time you use it to make sure the vehicle is in safe operating condition. Always follow the inspection and maintenance procedures and schedules described in Owner's Manual.



### **WARNING!**

Failures to inspect or maintain the vehicle properly increase the possibility of accident or equipment damage. Do not operate the vehicle if you find any problem. If a problem cannot be corrected by the procedures provided in this manual, have the vehicle inspected by TGB dealer.

### **Before using this vehicle, check the following points:**

ITEM	ROUTINE
Fuel	<ul style="list-style-type: none"> <li>◆ Check fuel level in fuel tank and ass recommended fuel if necessary.</li> <li>◆ Check fuel line for leakage. Correct if necessary.</li> </ul>
Engine oil	<ul style="list-style-type: none"> <li>◆ Check oil level in engine and add recommended oil to specified level if necessary.</li> <li>◆ Check ATV for oil leakage. Correct if necessary.</li> </ul>
Front Diff. gear oil	<ul style="list-style-type: none"> <li>◆ Check ATV for oil leakage. Correct if necessary.</li> </ul>
Rear Diff. gear oil	<ul style="list-style-type: none"> <li>◆ Check ATV for oil leakage. Correct if necessary.</li> </ul>
Coolant	<ul style="list-style-type: none"> <li>◆ Check coolant level in reservoir and add recommended coolant to specified level if necessary.</li> <li>◆ Check cooling system for leakage. Correct if necessary.</li> </ul>
Front brake	<ul style="list-style-type: none"> <li>◆ Check operation, if soft or spongy, has TGB dealer bleed hydraulic system.</li> <li>◆ Check brake pads for wear and replace if necessary.</li> <li>◆ Check brake fluid level in reservoir and add recommended brake fluid to specified level if necessary.</li> <li>◆ Check hydraulic system for leakage. Correct if necessary.</li> </ul>
Rear brake	<ul style="list-style-type: none"> <li>◆ Check operation and correct if necessary.</li> <li>◆ Lubricate cables if necessary.</li> <li>◆ Check lever and pedal free play and adjust if necessary.</li> </ul>
Throttle lever	<ul style="list-style-type: none"> <li>◆ Make sure that operation is smooth. Lubricate cable and lever housing if necessary.</li> <li>◆ Check lever free play and adjust if necessary.</li> </ul>
Control cables	<ul style="list-style-type: none"> <li>◆ Make sure that operation is smooth. Lubricate if necessary.</li> </ul>
Wheels and tires	<ul style="list-style-type: none"> <li>◆ Check wheel condition and replace if damaged.</li> <li>◆ Check tire condition and tread depth. Replace if necessary.</li> <li>◆ Check air pressure. Correct if necessary.</li> </ul>
Brake pedal	<ul style="list-style-type: none"> <li>◆ Make sure that operation is smooth. Lubricate pedal pivoting point if necessary.</li> </ul>
Brake levers	<ul style="list-style-type: none"> <li>◆ Make sure that operation is smooth. Lubricate pedal pivoting point if necessary.</li> </ul>
Axle boots	<ul style="list-style-type: none"> <li>◆ Check for cracks or damage and replace if necessary.</li> </ul>
Chassis fasteners	<ul style="list-style-type: none"> <li>◆ Make sure that all nuts, bolts and screws are properly tightened.</li> </ul>
Instruments, light and switches	<ul style="list-style-type: none"> <li>◆ Check operation and correct if necessary.</li> </ul>

## OPERATION

Read the Owner's Manual carefully before riding the ATV. If there is a control or function you do not understand, ask your dealer.



### **WARNING!**

Read the Owner's Manual carefully to become familiar with all controls in order to help prevent any loss of control, which could cause an accident or injury.

### **Engine break-in**

There is never a more important period in the life of your engine than the first 320 km (200 mi) or 20 hours of riding. For this reason, you should read the following material carefully. Since the engine is brand new, do not put an excessive load on it for the first 320 km (200 mi) or 20 hours. The various parts in the engine wear and polish themselves to the correct operating clearances.

During this period, prolonged full-throttle operation or any condition that might result in engine overheating must be avoided.

#### **0–160 km (0–100 mi) or 0–10 hours**

Avoid prolonged operation above 1/2 throttle. Vary the speed of the ATV regularly. Do not operate it at one set throttle position.

#### **160–320 km (100–200 mi) or 10–20 hours**

Avoid prolonged operation above 3/4 throttle. Rev the engine freely, but do not use full throttle at any time.

#### **320 km (200 mi) or 20 hours and beyond**

The ATV can now be operated normally.

### **Parking**

When parking the ATV, stop the engine, apply the brake, shift the drive select lever into the Neutral position, pull the parking brake lever to the right (parking) position.

### **Parking on a slope**



### **WARNING!**

Avoid parking on hills or other inclines. Parking on a hill or other incline could cause the ATV to roll out of control, increasing the chance of an accident. If you must park on an incline, place the ATV transversely across the incline, stop the engine, pull the parking brake lever to the parking position, and then block the front and rear wheels with rocks or other objects.

Do not park the ATV at all on hills that are so steep you could not walk up them easily.

1. Bring the ATV to a stop by applying the brakes.
2. Stop the engine.
3. Pull the parking brake lever to the right (parking) position.



## DESCRIPTION



1. Winch Switch
2. Starter Switch
3. Rear brake Lever
4. Head Lamp Switch
5. Hazard Switch
6. Horn
7. Winkle Switch
8. Over Ride





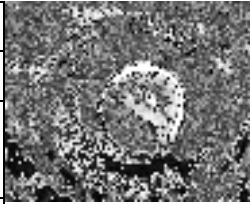

9. Speedometer
10. 2D/4D/LOCK Switch
11. Front Brake Lever
12. Throttle
13. Parking Lever
14. L/H/N/R Lever
15. Ignition Switch
16. Rear Differential Switch

# INTRUMENT AND CONTROL FUNCTION

## 1. IGNITION SWITCH FUNCTION / POSITION

Position	Function	Key Out	
	Position Lamp	NO	
<b>ON</b>	All electrical systems operational and Daytime running lamp	NO	
<b>OFF</b>	While parking	YES	

## 2. SIGNS AND FUNCTIONS

Position	Name	Function	
	Starter Switch	Start engine	
	Dimmer Switch	Hi-Beam/Lo-Beam Switch	
	Hazard Switch	Warning signal	
	Turn Signal Switch	Right/Left-hand direction	
	Horn	Sounded by pushing	

※ This vehicle is equipped with a safety protection system, to start the engine must be brake applied.

### Remove the function of over-ride

1. Set the shift gear at “R” then press over-ride button (keep press the button).
2. As you move your finger away from over-ride button, then speed will be limited again when reverse.



## 3. FRONT BRAKE LEVER

The front brake lever is located on the right handlebar. To apply the front brake, pull the brake lever toward the handlebar grip.

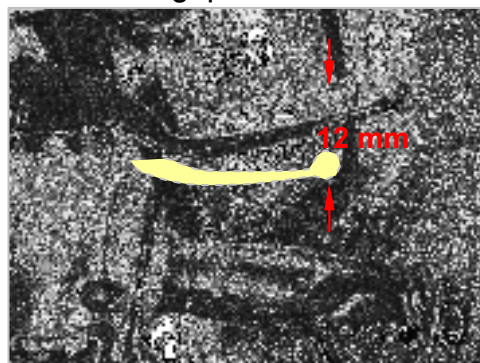

#### 4. REAR BRAKE LEVR AND BRAKE PEDAL

The rear brake lever is located on the left handlebar and the brake pedal is located on the right side of the ATV. To apply the rear brake, pull the brake lever toward the handlebar grip or push down on the brake pedal.

※ By pressing the pedal brake will activate the front and rear brakes.

By squeezing the rear brake lever may also activate the rear brake pedal.

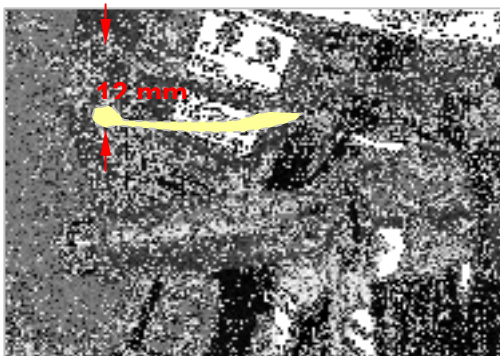

#### **WARNING!**

- ◆ Before each journey check whether the accustomed resistance exists with activity of the brake at the brake lever. Also check there is sufficient quantity of brake fluid in the reservoir.
- ◆ Before each trip check the brake actuating system. The gap of the brake lever end should be 12 mm approximately. Inform your local dealer of possible deviations.
- ◆ Irregularities of brakes such as leaks and poor performance should only be dealt with by an authorized dealer.

**NOTES:** The brake fluid level must be above the MIN mark. If the level keeps going down, have an authorized dealer check it.

Always use DOT #4 brake fluid.



## 5. SHIFT LEVER



**L:** High torque use (advance gear)

**H:** Normal use (driving gear)

**N:** Neutral

**R:** Reverse use

**P:** Parking use

### Shift lever instructions:

1. Engine starts only in Neutral (N) position.
2. Engage a brake and push the knob in and move the shift lever from N to H, L or R.  
(L shift is used for rough surfaces)

**※Shifting H to L and any gear/direction the vehicle must be at a complete stand still.**

3. For reverse, with the brake on, push the knob in and move the shift lever from N to R.

### Parking shift lever instructions:

1. Engage a brake and push the knob in then move the shift lever to “P” position.

Check the “P” indicator is bright on the dashboard.

2. Switching the parking break lever on the “Parking” position, make sure the parking procedure is completely.

3. At “P” position, the engine RPM was limited, open throttle will damage the damage.

For RPM checking or adjusting, please shift the lever to “N” position.



### CAUTION!

Operating the shift lever when vehicle is moving can be hazardous. This is strictly prohibited.

Always wait till the vehicle stops completely, do not operate the ATV at high speed in reverse under any circumstances.

## 6. Drive Mode Select

This ATV equipped with four kinds of drive mode with either front or rear differential function. You can choose the different mode depends on the different terrain.

### 6.1. Rear Drive only :

#### 6.1.1. 2WD



The ATV on the rear drive mode without Lock on the rear differential.

Power is supplied to the rear wheels with rear differential function.

This is mainly use for normal riding with both front and rear differential functions.

### 6.1.2. RWD

The ATV on the rear drive mode with Lock on the rear differential.

Power is supplied to the rear wheels without rear differential function.

This is mainly use for normal riding with front differential only.



## 6.2. All Wheels Drive :

### 6.2.1. 4WD

The ATV on the all wheels drive mode with Lock on the rear differential only.

Power is supplied to the rear and front wheels, with front differential function but without rear differential function.

This provides much more traction than 2WD and should be used when riding on wet and slippery surfaces.



### 6.2.2. LOCK

The ATV on the all wheels drive mode with Lock on both front and rear differentials, which means all wheels without differential function.

Power is supplied to the rear and front wheels without any differential function.

This provides all traction to four wheels and should be used when two or more wheels skid





### **WARNING!**

Always stop the ATV before changing from two-wheel drive to four-wheel drive and vice versa. The ATV handles differently in two-wheel drive than in four wheel drive in some circumstances. Changing from the two-wheel drive to four-wheel drive or vice versa while moving may cause the ATV to unexpectedly handle differently. This could distract the operator and increase the risk of losing control and causing an accident.



### **WARNING!**

Always ride at a slow speed when the ATV is in differential gear lock and allow extra time and distance for maneuvers.

All wheels turn at the same speed when the differential gear is locked, so it takes more effort to turn the ATV. The effort needed to turn increases with the riding speed. You may lose control and have an accident if you cannot make a sharp enough turn for the speed you are traveling.

### **NOTES:**

Riding before the differential gear lock is properly engaged will cause the vehicle speed to be limited until engagement is complete.



### **WARNING!**

Press the button when ATV is moving can be extremely dangerous can lose control while riding with hand moved from the handlebar. The gearbox mechanism can be damaged if pressing the shift button when ATV is in motion.

Always stop the ATV completely before shift between 2WD, RWD, 4WD and LOCK.

## **7. TIRES**

Check tire pressure regularly to make sure it is at the recommended specifications. Also check for wears and damage.

### **Tire pressure**

Use the low-pressure tire gauge to check and adjust tire pressure when tire are cold. Tire pressure must be equal on both sides.



### **WARNING!**

Operation of this vehicle with improper tire pressure may cause severe injury or death from loss control or rollover. Tire pressure below the minimum specified could also cause the tire to dislodge from the rim under severe riding condition.



Set the tire pressure to the following specifications:

Model		EST
Recommend	Front	7 psi (0.492kgf/cm <sup>2</sup> )
	Rear	7 psi (0.492kgf/cm <sup>2</sup> )

The low-pressure tire gauge is included as standard equipment. Make two measurements of the tire pressure and use the second reading. Dust or dirt in the gauge could cause the first reading to be incorrect.

### Tire wear limit

When the tire groove decreases to 3 mm (0.12 in) due to wear, replace the tire.

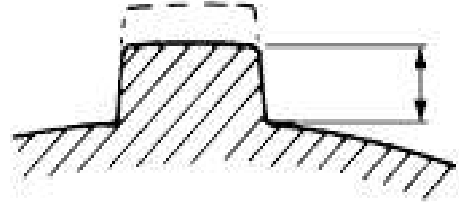

### Tire information

This ATV is equipped with tubeless tires with valves.



#### WARNING!

Use of improper tires on this ATV may cause loss of control, increasing your risk of an accident.

After extensive tests, only the tires listed below have been approved for this model by TGB.

Model		EST (with EPS)	EST (without EPS)
Front	Tubeless	AT26*8-14	AT25*8-12
Rear	Tubeless	AT26*10-14	AT25*10-12



#### WARNING!

Never attempt to change the tires without profession knowledge or skill. It will increase the risk of accident. Please contact your dealer for properly tires change.

### Aftermarket tires and rims

The tires and rims that came with your ATV were designed to match the performance capabilities and to provide the best combination of handling, braking and comfort. Other tires, rims, sizes and combinations may not be appropriate.

## 8. COOLANT

The coolant level should be checked before each ride. In addition, the coolant must be changed at the intervals specified in the periodic maintenance and lubrication chart.

### To check the coolant level

1. Place the ATV on a level surface.
2. Check the coolant level in the coolant reservoir.



## NOTES:

The coolant level must be checked on a cold engine since the level varies with engine temperature.

The coolant should be between the minimum and maximum level marks.

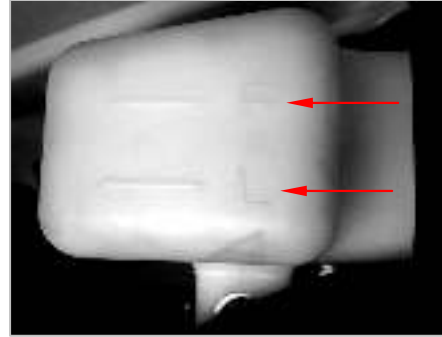
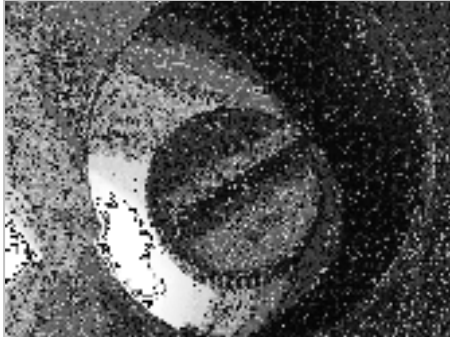

If the coolant is at or below the minimum level mark, remove the coolant reservoir cap, add coolant or distilled water to the maximum level mark and install the reservoir cap.



### CAUTION!

If coolant is not available, use distilled water or soft tap water instead. Do not use hard water since it is harmful to the engine. If water has been used instead of coolant, replace it with coolant as soon as possible; otherwise the cooling system will not be protected against frost and corrosion. If water has been added to the coolant, have a TGB dealer check the antifreeze content of the coolant as soon as possible, otherwise the effectiveness of the coolant will be reduced.

※Coolant reservoir capacity ( up to the maximum level mark): 1.2 L

## To change the coolant



### WARNING!

Wait for the engine and radiator to cool before removing the radiator cap. You could be burned by hot fluid and steam blown out under pressure. Always place a thick rag over the cap when opening. Allow any remaining pressure to escape before completely removing the cap.

1. Place the ATV on a level surface.
2. Remove front cover.
3. Place a container under the engine and then remove the coolant drain bolt and its gasket.
4. Remove the radiator cap.
5. Remove reservoir cap.
6. Disconnect the coolant reservoir hose on the coolant reservoir side and then drain the coolant from the coolant reservoir.
7. After draining the coolant, thoroughly flush the cooling system with clean tap water.
8. Install the coolant drain bolt and its new gasket and then tighten the bolt.



9. Connect the coolant reservoir hose.
10. Pour the recommended coolant into the reservoir to the maximum level mark and then install the reservoir cap.



#### **CAUTION!**

Mix antifreeze with distilled water only. However, if distilled water is not available, soft water may be used for refilling. Do not use hard water since it is harmful to the engine.

11. Pour the recommended coolant into the radiator until it is full.  
Antifreeze/water mixture ratio: 1:1

#### **Recommended antifreeze:**

High quality ethylene glycol antifreeze containing corrosion inhibitors for aluminum engines

#### **Coolant quantity:**

Radiator capacity (including all routes): 2.4 L

Reservoir capacity (up to the maximum level mark): 1.2 L

12. Install the radiator cap, start the engine let it idle for several minutes and then turn it off.
13. Remove the radiator cap to check the coolant level in the radiator. If it is low, add sufficient coolant until it reaches the top of the radiator then install the radiator cap.
14. Start the engine and then check for coolant leakage.
15. Install the front cover.

## **9. STEERING LOCK**









The steering lock in principle should be used for theft protection. The handlebar is to be turned to the left and the key in the steering lock pressed and turned simultaneously as shown.

## 10. SPEEDOMETER



### PANEL DESCRIPTIONS

- |                      |                          |
|----------------------|--------------------------|
| 1. Fuel Meter bar.   | 5. Driving Mode          |
| 2. Speedometer.      | 6. EPS indicator.        |
| 3. Function display. | 7. LED Indicator symbols |
| 4. MODE Button       | 8. SET Button            |

	Daytime running lamp / Green		Turn single indicator/ Green
	Main-Beam Headlamp/Blue	L/H	Drive Gear/ Green
	Engine oil indicator/Red	N	Neutral Gear/ Green
	Battery charge indicator	R	Reverse Gear/ Red
	Engine coolant Temperature/ Red	P	Parking Gear/ Green
	Engine check / Yellow		

1. Engine oil indicator (Red): if this light turns on, please check if it is enough engine oil, otherwise, please contact with your local dealer for inspection.
  2. Temperature indicator (Red): if light turn on with engine running, implies cooling system problem. Please contact with your local dealer for inspection.
  3. Battery charge warning light: if the light turns on while engine running, implies malfunction of battery system. Please contact with your local dealer for inspection.
- ※When turn on ignition switch, engine oil indicator/temperature indicator/battery indicator will self-diagnostic, if this process is not found, could be some malfunction. Please contact with your local dealer for inspection.
4. Turn signal light (Green): on use of turn signal, lights will flash and audible warning. Hazard warning: left/right light will flash and audible warning.
  5. Engine check light (Yellow): if this light turns on, please contact with your local dealer for inspection.
  6. ESP “FAIL” blinking indicate EPS malfunction and the defect code will shown on the bottom line of screen with “c????”, please contact with your local dealer.



## **WARNING!**

Engine oil warning light will light up when low on oil. Please proceed to fill with TGB special oil, after filling up, warning light will turn-off. Please always ride the vehicle with the engine oil warning light off, otherwise, it will cause damage to the engine. It will cause severe damage to the engine if engine keep running under overheating circumstances.

## **FUNCTIONS DISPLAY**

### **RPM: Digital Tachometer**

1. RPM is displayed in 2nd row.
2. Digital tachometer displays up to 12,000 RPM.
3. Tachometer signal picked up from either ECU or Ignition coil.

### **MAX RPM: Maximum Tachometer**

1. MAX RPM is displayed on 2nd row.
2. Displays highest tachometer reading achieved after last RESET operation.

### **SPEED: Speed Meter**

1. Speed meter display is on 1st row of the screen.
2. Displays speedometer reading up to 199 Km/H or 124 MPH.

### **MAX SPEED: Maximum Speed Meter**

1. MAX is displayed on 2nd row.
2. Displays highest speed achieved after last RESET operation.

### **SPEED AVG: Average Speed Meter**

1. AVG is displayed on 2nd row.
2. Calculates average speed from last RESET.

### **TRIP A & TRIP B: Trip Meter A & B**

1. TRIP function registers cumulative trip distance from last RESET while bike is being ridden.
2. Display is on 2nd row of screen.

### **ODO: Odometer**

1. ODO registers cumulative distance traveled during motorbike operation.
2. ODO data is stored in memory even when power is off.

### **RT: Riding Timer**

1. Calculates total operation time from last RESET.
2. Count automatically begins with vehicle movement.

### **TT: Total Riding Timer**

1. Calculates total operation time from the beginning of bike use.
2. Count automatically begins with vehicle movement.
3. TT data is stored in memory even when power is off.

## **FUEL METER**

1. Have 7 bar graphic indicator of fuel status.

2. Last bar flashes to indicate low fuel level.

### **DTC : Diagnostic Trouble Code**

1. When EFI system failure, there is a defect code “P????” at 2<sup>nd</sup> row display.
2. When EPS malfunction, there is a defect code “c????” at 2<sup>nd</sup> row of display.

### **BUTTON OPERATIONS**

#### **MODE BUTTON**

1. Press the MODE button to move all functions in loop sequence from one function screen to another.

**ODO → RPM → TRIP A → TRIP B → MAX SPEED → SPEED AVG → RT → TT → MAX RPM → TIME → EPS → ODO**

2. Press MODE for 10 seconds to change the display for KMH or MPH.

#### **RESET FUNCTION**

1. Press MODE to the desired screen then press MODE and SET button simultaneously for 6 seconds to reset the data from stored values to zero. Each reset are individually, including TRIP A, TRIP B, RT, AVG SPEED, MAX SPEED and MAX RPM.
2. ODO, Clock and TT data cannot be reset.

#### **TIME FUNCTION**

1. Press MODE to the TIME screen then presses MODE and SET button simultaneously for 3 seconds to set up the time.
2. When the digit is blinking, press SET button to desire digit then press MODE button to set up and jump to next digit.
3. After the time setting, press MODE and SET button simultaneously for save and back to ODO screen.
4. During setting, if the digit did not change over 10 seconds, the setting will auto save and back to time screen.
5. When speed over 10km/hr, the setting will save automatically.

#### **EPS (Electric Power Steering) FUNCTION**

The EPS indicator comes on when you press the MODE button and go to EPS function. You can select engage or disengage the EPS function if needed. The indicator remain on when EPS is engage and the ignition is turn ON, you can set up the steering torque to Max or Min.

**MIN:** Small steering torque, used for smooth terrain and high speed.

**MAX:** Large steering torque, used for rough terrain and low speed.

**FAIL:** ESP failure, blinking indicate EPS malfunction and the defect code will shown on the bottom line of screen with “c????”.

## 11. SPARK PLUG

### Checking the spark plug

The spark plug is an important engine component, which is easy to check. Since heat and deposits will cause any spark plug to slowly erode, the spark plug should be removed and checked in accordance with the periodic maintenance and lubrication chart. In addition, the condition of the spark plug can reveal the condition of the engine.

### To remove the spark plug

1. Remove spark plug cap.
2. Remove the spark plug with spark plug wrench.

### To check the spark plug

1. Check that the porcelain insulator around the center electrode of the spark plug is a medium to light tan (the ideal color when the ATV is ridden normally).

### NOTES:

If the spark plug shows a distinctly different color, the engine could be operating improperly. Do not attempt to diagnose such problems yourself. Instead have a TGB dealer check the ATV.

2. Check the spark plug for electrode erosion and excessive carbon or other deposits and replace it if necessary.

**Specified spark plug:** DENSO / XU24EPR-U

3. Measure the spark plug gap with a wire thickness gauge and if necessary, adjust the gap to specification.

**Spark plug gap:** 0.7~0.8 mm

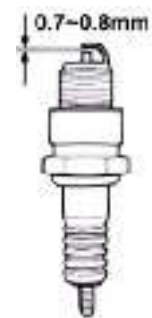

### To install the spark plug

1. Clean the surface of the spark plug gasket and its mating surface and then wipe off any grime from the spark plug threads.
2. Install the spark plug with the spark plug wrench and then tighten it to the specified torque.

**Tightening torque:** 180 kgf/cm

### NOTES:

If a torque wrench is not available when installing the spark plug, a good estimate of the correct torque is 1/4-1/2 turn past finger tight. However the spark plug should be tightened to the specified torque as soon as possible.

3. Install the spark plug cap.

## 12. AIR CLEANER



1. Lift and Open the access cover.
2. Follow the direction arrow to loosen and remove the element.
3. Clean the element with non-flammable or high-flash point solvent and then squeeze it completely dry.



### **WARNING!**

Always use parts cleaning solvent to clean the sponge material. Never use low-flash-point solvents or gasoline to clean the sponge material because the engine could catch fire or explode.

Squeeze the excess solvent out of the sponge material and let it dry.



### **CAUTION!**

Do not twist the sponge material when squeezing it.

Apply foam air filter oil or other quality foam air filter oil to the sponge material.

**NOTES:** The sponge material should be wet but not dripping.

## 13. ENGINE OIL AND OIL FILTER

The engine oil level should be checked before each ride. In addition, the oil must be changed and the oil filter replaced at the intervals specified in the periodic maintenance and lubrication chart.

### **To check the engine oil level**

1. Place the ATV on a level surface.
2. Check the engine oil level on a warm engine.

### **NOTES:**

If the engine was started before checking the oil level, be sure to warm up the engine sufficiently and then wait at least ten minutes until the oil settles for an accurate reading.

3. Remove the engine oil filler cap then wipe the engine oil dipstick off with a clean rag.

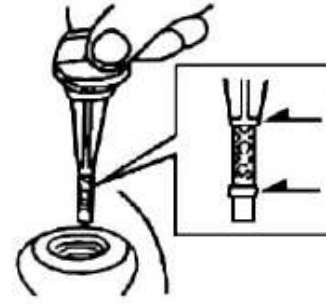
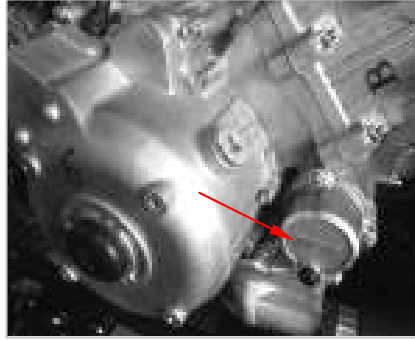
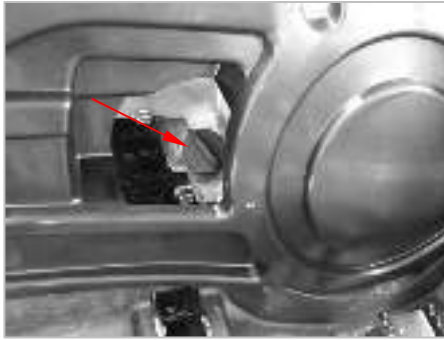

4. Insert the dipstick into the filler hole (with screwing it in) and then remove it again to check the oil level.

**NOTES:**

The engine oil should be between the tip of the dipstick and the maximum level mark.

5. If the engine oil is not between the tip of the dipstick and the maximum level mark, add sufficient oil of the recommended type to raise it to the correct level.

**NOTES:**

Be sure the engine oil is at the correct level, otherwise engine damage may result.

6. Insert the dipstick into the oil filler hole and then tighten the engine oil filler cap.

**To change the engine oil (with or without oil filter replacement)**

1. Place the ATV on a level surface and raise up with lift jack.
2. Start the engine, warm it up for several minutes and then turn off.
3. Place an oil pan under the engine to collect the used oil.
4. Remove the engine oil drain bolt and its washer to drain the oil from the crankcase.

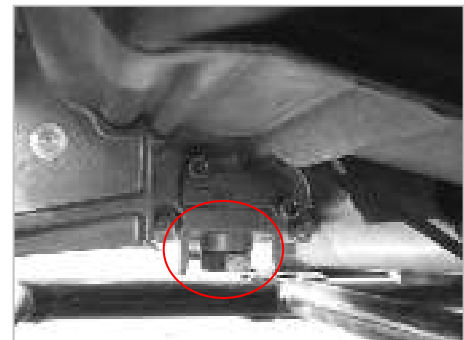

**NOTES:**

Dispose of lubricant in accordance with local regulations.

✘ Skip the steps 5-7, if the oil filter cartridge is not being replaced.

5. Remove the **cover** and right internal fender.
6. Remove the three screws of oil filter cap.
7. Apply a thin coat of engine oil to the O-ring of new oil filter.
8. Install the new oil filter and tighten the screws of the cap.

**Tighten torque: 180kgf/cm**

9. Install the engine oil drain bolt and its new washer and then tighten the bolt to the specified torque.

**Tighten torque: 230kgf/cm**

10. Refill with the specified amount of the recommended engine oil and then install and tighten the engine oil filler cap.

**Oil Grade: 15W-40**

**Oil quantity:**

Without oil filter replacement: **1.8 L**

With oil filter replacement: 2.0 L

New engine: 2.3 L

**※Be sure to wipe off spilled oil on any parts after the engine and exhaust system have cooled down.**



**CAUTION!**

In order to prevent clutch slippage (since the engine oil also lubricates the clutch), do not mix any chemical additives.

Make sure that no foreign material enters the crankcase.

11. Start the engine and then let it idle for several minutes while checking it for oil leakage. If oil is leaking, immediately turn the engine off and check for the cause.
12. Turn the engine off, wait at least ten minutes and then check the oil level and correct it if necessary.

#### 14. TRANSMISSION GEAR OIL

##### To check the transmission gear oil level

1. Place the ATV on a level surface.
2. Remove the cover and check bolt then check the oil level in the transmission case. The oil level should be at the brim of the check hole.
3. If the oil is below the brim of the check hole, add sufficient oil of the recommended type to raise it to the correct level.
4. Install the check bolt and tighten with specified torque.



**Tighten torque:** check bolt: 80kgf/cm

##### To change the transmission gear oil

1. Place the ATV on a level surface and raise up with lift jack.
2. Place an oil pan under the transmission case to collect the used oil.
3. Remove the transmission gear oil drain bolt and its washer to drain the oil from the transmission case.

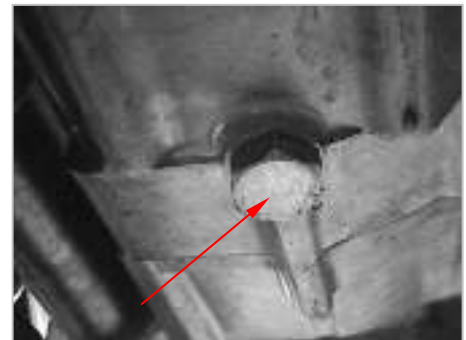

#### NOTES:

Dispose of lubricant in accordance with local regulations.

4. Install the drain bolt and washer then tighten the bolt to the specified torque.

**Tighten torque:** 330kgf/cm



- Loosen the clamp and remove the breath hose then refill with recommended transmission oil.

**Oil quantity:** SAE# 90, 0.8 L

- Install the breath hose and tighten the clamp.
- Check the transmission case for oil leakage. If oil is leaking, check for the cause.



## 15. FRONT DIFFERENTIAL GEAR OIL

The differential gear case must be checked for oil leakage before each ride. If any leakage is found, have a TGB dealer check and repair the ATV. In addition, the differential gear oil level must be checked and the oil changed as follows at the intervals specified in the periodic maintenance and lubrication chart.

### To check the differential gear oil level

- Place the ATV on a level surface.
- Remove the differential gear oil filler bolt and its gasket and then check the oil level in the differential gear case. The oil level should be at the brim of the filler hole.

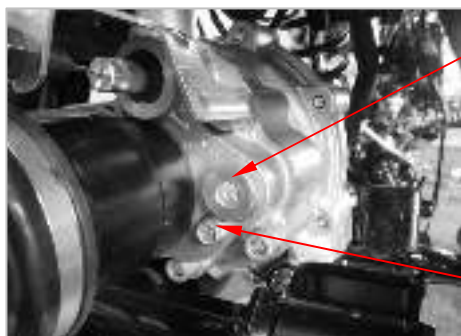

Filler bolt

Check bolt

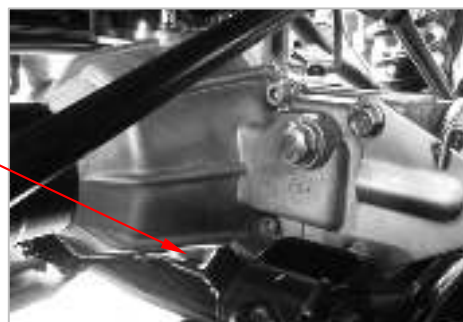

Drain bolt

- If the oil is below the brim of the filler hole, add sufficient oil of the recommended type to raise it to the correct level.
- Check the gasket for damage and replace it if necessary.
- Install the oil filler bolt and its gasket and then tighten the bolt to the specified torque.

### Tighten torque:

Differential gear oil filler bolt: 330kgf/cm

check bolt: 80 kgf/cm

Drain bolt

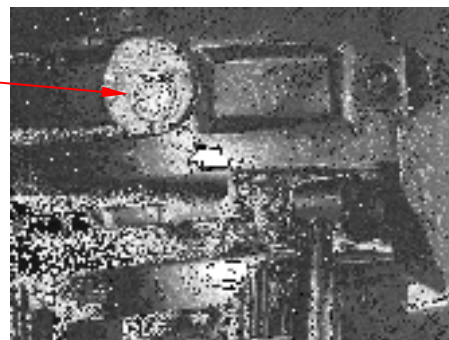

### To change the differential gear oil

- Place the ATV on a level surface and raise up with lift jack.
- Place an oil pan under the differential gear case to collect the used oil.
- Remove the differential gear oil filler bolt, the differential gear oil drain bolt and their gasket to drain the oil from the differential gear case.

## NOTES:

Dispose of lubricant in accordance with local regulations.

4. Install the drain bolt and its new gasket and then tighten the bolt to the specified torque.

**Tighten torque:** 330kgf/cm

5. Refill with recommended differential gear oil.

**Oil quantity:** SAE# 90, 0.35 L

6. Check the oil filler bolt gasket for damage and replace it if necessary.
7. Install the oil filler bolt and its gasket and then tighten the bolt to the specified torque.

**Tighten torque:** 330kgf/cm

8. Check the differential gear case for oil leakage. If oil is leaking, check for the cause.

## 16. REAR DIFFERENTIAL GEAR OIL

The final gear case must be checked for oil leakage before each ride. If any leakage is found, have a TGB dealer check and repair the ATV. In addition, the final gear oil level must be checked and the oil changed as follow at the intervals specified in the periodic maintenance and lubrication chart.

### To check the rear differential gear oil level

1. Place the ATV on a level surface.
2. Remove the final gear oil filler bolt and its gasket and then check the oil level in the final gear case. The oil level should be at the brim of the filler hole.

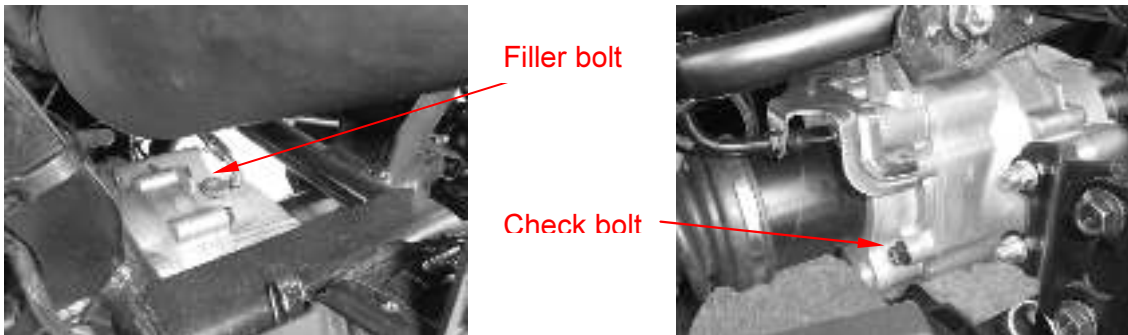

3. If the oil is below the brim of the filler hole, add sufficient oil of the recommended type to raise it to the correct level.
4. Check the oil filler bolt gasket for damage and replace it if necessary.
5. Install the oil filler bolt and its gasket and then tighten the bolt to the specified torque.

### **Tighten torque:**

*Final gear oil filler bolt:* 330kgf/cm

*Check bolt:* 80 kgf/cm

### To change the rear differential gear oil

1. Place the ATV on a level surface and raise up with lift jack..
2. Place an oil pan under the final gear case to collect the used oil.
3. Remove the final gear oil filler bolt; the final gear oil drain bolt and their gasket to

drain the oil from the final gear case.

#### NOTES:

Dispose of lubricant in accordance with local regulations.

4. Install the drain bolt and its new gasket and then tighten the bolt to the specified torque.

**Tighten torque:** 330kgf/cm

5. Refill with the recommended final gear oil to the brim of the filler hole as shown.

**Oil quantity:** SAE#90, 0.5 L

6. Check the oil filler bolt gasket for damage and replace it if necessary.

7. Install the oil filler bolt and its gasket and then tighten the bolt to the specified torque.

**Tighten torque:** 330kgf/cm

8. Check the final gear case for oil leakage. If oil is leaking, check for the cause.

Drain bolt

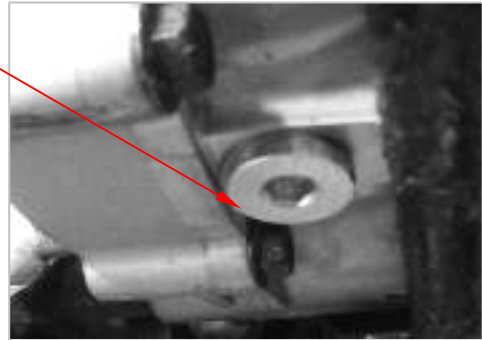

#### 17. SEAT

##### To remove the seat

1. Opening the lock by turning the key.
2. Pull up the seat at rear.

##### To install the seat

Insert the tongue on the front of the seat into seat holders and push down on the seat at the rear. Make sure that the seat is securely fitted.



#### 18. Fuel Tank

Insert the key and turn. The refill port is on the right of rear bumper when turn the key the cap will open automatically.



#### 19. STORAGE COMPARTMENTS

This ATV equipped with two storage compartments, which located at the front right and left side. To access the storage compartment, insert the key and turning, remove the storage compartment cover.

When storing any documents in the storage compartments, be sure to wrap them in a plastic bag so that they will not wet. When washing the ATV, be careful not to let any water enter the storage compartments.

A drain plug is fitted at the bottom of the front storage compartment. If any water collects in a storage compartment, remove the drain plug and drain the water then install them.

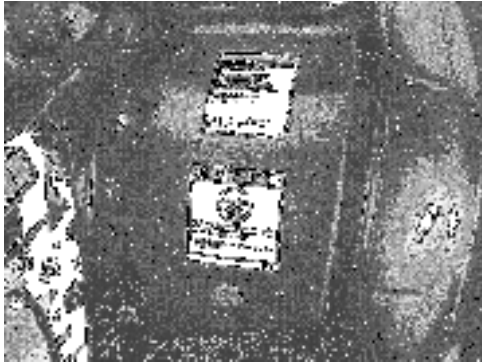

Drain plug

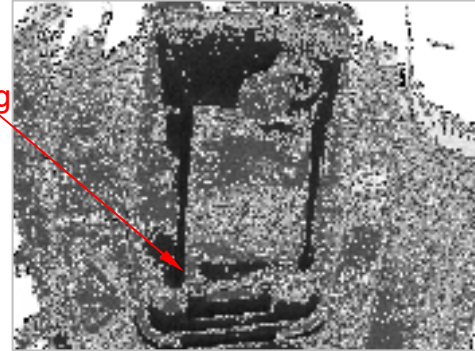

## 20. FUSES AND BATTERY

### BATTERY

The battery is located under the seat. This model is equipped with a free maintenance battery. There is no need to check the electrolyte or to add distilled water. However, the battery lead connections need to be checked and if necessary tightened.



### WARNING!

Battery electrolyte is poisonous and dangerous as it contains sulfuric acid, which can cause severe burns. Avoid contact with skin, eyes or clothing. Always shield your eyes when working near batteries.

Batteries produce explosive gases. Keep sparks, flame, cigarettes or other sources of ignition away. Ventilate when charging or using in an enclosed space.

**KEEP OUT OF REACH OF CHILDREN**

### To remove the battery

1. Remove the seat.
2. Remove the battery holding plate by removing the bolts.
3. Disconnect the negative battery lead first then the positive battery lead by removing their bolt.
4. Pull the battery out of its compartment.



### CAUTION!

When removing the battery, the main switch must be off and the negative lead must be disconnected before the positive lead.

### To charge the battery

Have a TGB dealer charge the battery as soon as possible if it seems to have discharged. Keep in mind that the battery tends to discharge more quickly if the ATV is equipped with optional electrical accessories.



#### CAUTION!

To charge free maintenance battery, a special (constant voltage) battery charger is required. Using a conventional battery charger will damage the battery.

### To store battery

1. If the ATV will not be used for more than one month, remove the battery, fully charge it and then place it in a cool dry place.
2. If the battery will be stored for more than two months, check it at least once a month and fully charge it if necessary.



#### CAUTION!

Always keep the battery charged. Storing a discharged battery can cause permanent battery damage.

### To install the battery

1. Place the battery in its compartment.
2. Connect the positive battery lead first then connect the negative battery lead by installing their bolt.



#### CAUTION!

When installing the battery, the main switch must be off and the positive lead must be connected before the negative lead.

3. Install the battery holding plate by installing the bolts.
4. Install the seat.

### FUSES

There are two fuse box, one is main fuse box and other is EPS fuse box.

For **EPS** model, the MAXI fuse is located in the EPS fuse box which is on the right side under the seat.

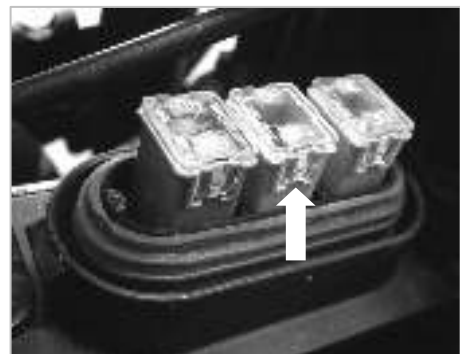



For **Non EPS** model, the MAXI fuse is located beside the starter relay.



### Replacing a fuse

The main fuse box and the EPS fuse box are located under the seat.

HEAD HI 15A	IGNITION 10A	TAIL 10A		F.P RELAY
HEAD LO 15A	P-SOURCE 10A	SPACE FUSE 20A		
FUEL PUMP 10A	P-SOURCE 10A	FAN RELAY		MAIN.P RELAY
EPI SYSTEM 10A	FAN 20A			



EPS 40A	MAXI 30A	CHARGER 30A
GREEN	PINK	PINK



If a fuse is blown, replace it as follows.

1. Turn the key to "OFF" and turn off all electrical circuits.

#### CAUTION!

To prevent accident short-circuiting; turn off the main switch when checking or replacing fuse.

2. Remove the blown fuse and then install a new fuse of the specified amperage.

#### WARNING!

Always use a fuse of the specified rating and never use a substitute object in place of the proper fuse. An improper fuse or a substitute object can cause damage to the electrical system, which could lead to a fire.

3. Turn the key "ON" and turn on the electrical circuits to check if the devices operate.
4. If the fuse immediately blows again, have a TGB dealer check the electrical system.

## 21. REPLACING A HEADLIGHT BULB

If a headlight bulb burns out, replace it as follows.

1. Remove the cover at the rear of the headlight by pulling it off.

2. Remove the headlight bulb holder cover by pulling it off.

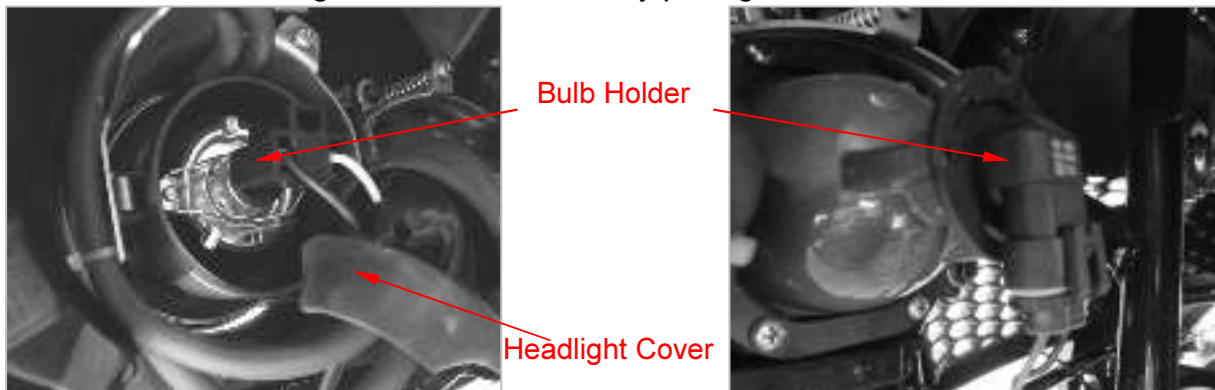

3. Removing the headlight bulb holder by pushing it in and turning it counterclockwise.

4. Remove the burnt out bulb by pulling it out.

5. Insert a new headlight bulb into the bulb holder by pushing it in.

**⚠ CAUTION!**

Do not touch the glass part of the headlight bulb to keep it free from oil, otherwise the transparency of the glass; the luminosity of the bulb and the bulb life will be adversely affected. Thoroughly clean off any dirt and fingerprints on the headlight bulb using a cloth moistened with alcohol or thinner.

6. Install the bulb holder by pushing it in and turning it clockwise.

7. Install the bulb holder cover and the cover at the rear of headlight bulb holder cover is securely fitted over the bulb holder and seated properly.

8. Adjust the headlight beam if necessary.

### Adjusting a headlight beam

**⚠ CAUTION!**

It is advisable to have a TGB dealer make this adjustment.

To raise a headlight beam, turn the headlight beam adjusting screw in clockwise.

To lower a headlight beam, turn the adjusting screw in counterclockwise.

## 22. REPLACING THE TAIL/BRAKE LIGHT BULB

If the tail /brake light bulb burns out, replace it as follows.

1. Disconnect the wiring of tail/brake light.
2. Remove the two nuts and washers at the rear of the tail/brake light and pulling it off.
3. Replace and install the new tail/brake light and connect the wiring.
4. Tighten the two bolts and washers.



## 23. AUXILIARY DC JACK

The auxiliary DC jack is located at the front right side of the ATV. The Auxiliary DC jack

can be used for suitable work lights, radios...etc. The auxiliary DC jack should only be used when the engine is running and light switch is set to "OFF". When the auxiliary DC jack be used the electric current should not exceed 5 A.

1. Set the light switch to "OFF".
2. Turn the accessory off.
3. Start the engine.
4. Open the auxiliary DC jack cap and then insert the accessory power plug into the jack.
5. Turn the accessory on.
6. When the auxiliary DC jack is not being used, cover it with the cap.

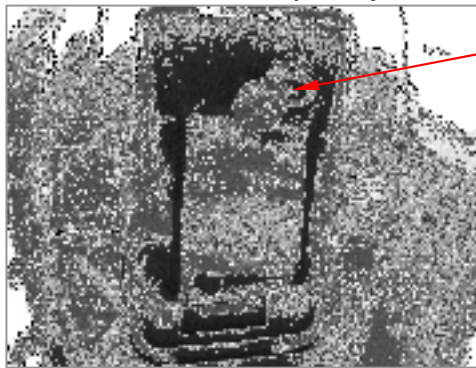

DC jack



#### CAUTION!

- ◆ Do not use accessories requiring more than 5 A. This may overload the current and cause the fuse to blow.
- ◆ If accessories are used without the engine running or with the headlights turn on, the battery will lose its charge and engine starting may become difficult.
- ◆ Do not use an automotive cigarette lighter or other accessories with plug that gets hot because the jack can be damaged.



## PRECAUTION OF ATV RIDING

This ATV is for recreation and utility use. This section, riding your ATV, provides general ATV riding instructions for recreational riding. The skills and techniques described in this section however are appropriate for all types of riding. Riding your ATV requires special skills acquired through practice over a period of time. Take the time to learn the basic techniques well before attempting more difficult maneuvers.

**Be sure you have read this Owner's Manual completely and understand the operation of the controls. Pay particular attention to the safety information. Also read all warning and notice labels on your ATV.**

## RIDE WITH CARE

Get training if you are inexperienced.



### WARNING!

Do not operate this ATV or allow anyone else to operate it without proper instruction. The risk of an accident is greatly increased if the operator does not know how to operate the ATV properly in different situations and on different types of terrain. Do not operate this ATV at speeds too fast for your skills or the conditions as this increases your chances of losing control of the ATV and an accident. Always go at a speed that is proper for the terrain, visibility and operating conditions and your experience.

**Beginning and inexperienced operator should complete the certified training course.** They should then regularly practice the skills learned in the course and the operating techniques described in this Owner's Manual.

### **Riding your ATV requires skills acquired through practice over a period of time.**

Do not attempt to operate at maximum performance until you are totally familiar with the ATV's handling and performance characteristics. Take the time to learn the basic techniques well before attempting more difficult maneuvers. Become familiar with this ATV at slow speeds first, even if you are an experienced operator.

**Not recommended for children under 16 years of age.**



### WARNING!

A child under 16 should never operate an ATV with engine size greater than 90 cc. Use by children of ATV's that are not recommended for their age can lead to severe injury or death of child.



## Apparel

Always wear the following to reduce risk of injury in an accident:

- ♦ **Approved motorcycle helmet that fits properly.**
- ♦ **Eye protection (goggles, helmet face shield or protective eyewear)**
- ♦ **Over the ankle boots, gloves, long sleeved shirt or jacket and long pants.**

An approved helmet and other personal protective equipment can reduce the severity of injuries in an accident.



### **WARNING!**

Operating without an approved motorcycle helmet increases your chances of a severe head injury or death in the event of an accident.

Wear eye protection when operating your ATV to reduce the risk of a serious accident or injury. Eye protection such as a face shield or goggles may reduce the risk of foreign material getting in your eyes and help prevent loss of vision.



### **WARNING!**

Operating without eye protection can result in an accident and increases your chances of a severe injury in the event of an accident.



## **Do not operate after or while consuming alcohol or drugs.**

The operator's performance capability is reduced by the influence of alcohol or drugs.

Consuming alcohol or drugs could seriously affect your judgment cause you to react more slowly and affect your balance and perception.



### **WARNING!**

**Never consume alcohol or drugs before or while driving this ATV. You increase your chance of an accident.**

## Loading and accessories



### **WARNING!**

Improper loading or towing can increase the risk of loss of control, an overturn or other accident. To reduce the risk of an accident:

- ◆ **Do not exceed the maximum loading limits for the vehicle.**
- ◆ Keep weight on racks centered side to side and as low as possible. Be sure cargo is secured- a loose load could change handling unexpectedly.
- ◆ Make sure the load does not interfere with your control or ability to see where you are going.
- ◆ Tie down cargo in the trailer securely. Make sure cargo in the trailer cannot move around. A shifting load can cause an accident.
- ◆ Reduce speed and allow more room to stop. A heavier vehicle takes longer to stop.
- ◆ Avoid hills and rough terrain. Choose terrain carefully. Use extreme caution when towing or carrying a load on inclines.
- ◆ Turn gradually and go slowly.

Take extra precautions when driving with a load or trailer. Follow these instructions and always use common sense and good judgment when carrying cargo or towing a trailer.

### **MAXIMUM LOADING LIMIT**

**Front carrier: 30 kg (66 lb)**

**Rear carrier: 50 kg (110 lb)**

**Trailer hitch: 200 kg (440 lb)**

Drive more slowly than you would without a load. The more weight you carry, the slow you should go. It is good practice to drive slowly (shift into first gear or low drive if available on this model) whenever you are carrying heavier loads or when towing a trailer.

## **During operation**

Always keep your feet on the footboards during operations.



### **WARNING!**

Removing even one hand or foot can reduce your ability to control the ATV or could cause you to lose your balance and fall off of the ATV.

Avoid wheels and jumping.



### **WARNING!**

Attempting wheels, jumps and other stunts increases the chance of an accident, including an overturn. Never attempt stunts, such as wheels or jumps. Don't try to show off.

## **Modifications and accessories**

Never modify this ATV through improper installation or use of accessories or other modification. All parts and accessories added to this ATV should be genuine TGB or equivalent components designed for use on this ATV and should be installed and used according to instructions. If you have question, please consult an authorized ATV dealer.

**WARNING!**

Operating this ATV with improper modifications may cause changes in handling, which in some situations could lead to an accident.

**Exhaust system****WARNING!**

- ◆ Dry grass or brush or other combustible material accumulated around the engine area could catch fire. Do not operate, idle or park the ATV in dry grass or other dry ground cover. Keep the engine area free of dry grass, brush or other combustible material.
- ◆ Someone touching the exhaust system during or after operation could be burned. Do not touch the hot exhaust system; do not park the ATV in a place where others might be likely to touch it.

The muffler and other engine parts become extremely hot during operation and remain hot after the engine has stopped. To reduce the risk of fire during operation or after leaving the ATV, do not let brush, grass and other materials collect under the vehicle, near the muffler or exhaust pipe or next to other hot parts. Check under the vehicle after operating in areas where combustible materials may have collected. Do not idle or park the vehicle in long dry grass or other dry ground cover.

To prevent burns, avoid touching the exhaust system. Park the ATV in a place where pedestrians or children are not likely to touch it.

**BE CAREFUL WHERE YOU RIDE**

This ATV is designed for OFF-ROAD use.

**WARNING!**

Paved surfaces may seriously affect handling and control of the ATV and may cause the ATV to go out of control. Always avoid paved surfaces, including sidewalks, driveways, parking lots and streets.

**Do not ride on any public road, street or highway. Riding on public roads can result in collisions with other vehicles. In many states it is illegal to operate ATVs on public streets, roads and highways.**

**WARNING!**

**Never operate this ATV on any public street, road or highway, even dirt or gravel one. You could collide with another vehicle.**

Know the terrain where you ride. Ride cautiously in unfamiliar areas. Stay alert for holes, rocks or roots in the terrain and other hidden hazards, which may cause the ATV to upset.

**WARNING!**

The ATV could go out of control if you do not have enough time to react to hidden rocks, bumps or holes. Go slowly and be extra careful when operating on unfamiliar terrain. Always be alert to changing terrain conditions when operating the ATV.

Do not operate on rough, slippery or loose terrain until you have learned and practiced the skills necessary to control the ATV on such terrain. Always are especially cautions on these kinds of terrain.

**WARNING!**

Failure to use extra care when operating on excessively rough, slippery or loose terrain could cause loss of traction or ATV control which could result in an accident, including an overturn.

When riding in an area where you might not easily be seen such as desert terrain, mount a caution flag on the ATV. DO NOT use the flagpole bracket as a trailer hitch.

**WARNING!**

You could collide with another vehicle if operating in off-road areas where you cannot easily be seen. Mount a caution flag on the ATV to make you more visible. Watch carefully for other vehicles.

Do not ride in areas posted “ no trespassing”.

Do not ride on private property without getting permission.

Select a large and flat area off-road to become familiar with your ATV. Make sure that this area is free of obstacles and other riders. You should practice control of the throttle, brakes, shifting procedures and turning techniques in this area before trying more difficult terrain. Shift to the park position and follow the instruction to start the engine. Once it has warmed up you are ready to begin riding your ATV. With the engine idling, shift the drive select lever into the low gear position or high gear position. Apply the throttle slowly and smoothly. If the throttle is applied too abruptly, the front wheels may lift off the ground, resulting in a loss of directional control. Avoid higher speeds until you are thoroughly familiar with operation of your ATV.

When slowing down or stopping, release the throttle and apply the brakes smoothly and evenly. Improper use of the brakes can cause the tires to lose traction, reducing control and increasing the possibility of an accident.

**CAUTION!**

Do not shift from low gear to high gear without coming a complete stop. Damage to the engine or drive train may occur.

## TURNING YOUR ATV



### **WARNING!**

Always follow proper procedures for turning as described in this Owner's Manual. Practice turning at low speeds before attempting to turn at faster speeds. Do not turn at speeds too fast for your skills or the conditions. ATV could go out of control and causing a collision or overturn.

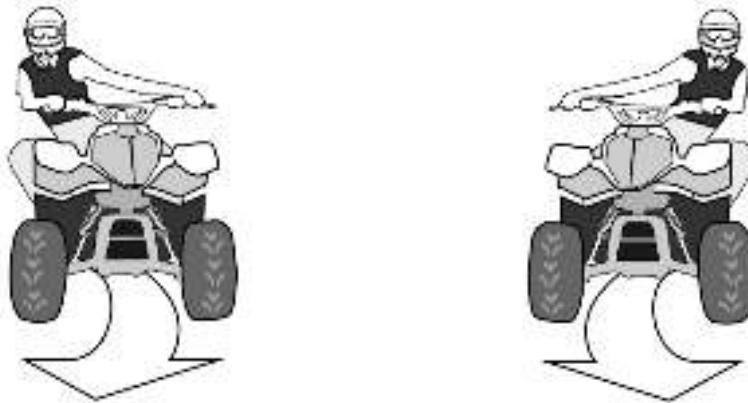

To achieve maximum traction while riding off-road, the two rear wheels turn together at the same speed. Therefore, unless the wheel on the inside of the turn is allowed to slip or lose some traction, the ATV will resist turning. A special turning technique must be used to allow the ATV to make turns quickly and easily. It is essential that this skill be learned first at low speed.

As you approach a curve, slow down and begin to turn the handlebars in the desired direction. As you do so, put your weight on the footboard to the outside of the turn (opposite your desired direction) and lean your upper body into the turn. Use the throttle to maintain an even speed through the turn. This maneuver will let the wheel on the inside of the turn slip slightly allowing the ATV to make the turn properly.

This procedure should be practiced at slow speed many times in a large off-road area with no obstacles. If an incorrect technique is used, your ATV may continue to go straight. If the ATV doesn't turn, come to a stop and then practice the procedure again. If the riding surface is slippery or loose, it may help to position more of your weight over the front wheels by moving forward on the seat.

Once you have learned this technique, you should be able to perform it at higher speeds or in tighter curves.

Improper riding procedures such as abrupt throttle changes, excessive braking, incorrect body movement or too much speed for the sharpness of the turn may cause the ATV to tip. If the ATV begins to tip over to the outside while negotiating a turn, lean more to the inside. It may also be necessary to gradually let off on the throttle and steer to the outside of the turn to avoid tipping over.

Remember: Avoid higher speeds until you are thoroughly familiar with the operation of your ATV.

## CLIMBING UPHILL



### **CAUTION!**

Climbing hills improperly can cause overturns or loss of control. Use proper riding techniques described in this Owner's Manual.

- ◆ Never operate the ATV on hills too steep for the ATV or for your abilities. The ATV can overturn more easily on extremely steep hills than on level surfaces or small hills.
- ◆ Always check the terrain carefully before you start up any hill. Never climb hills with excessively slippery or loose surfaces.
- ◆ Shift your weight forward.
- ◆ Never open the throttle suddenly. The ATV could flip over backwards.
- ◆ Never go over the top of any hill at high speed. An obstacle, a sharp drop or another vehicle or person could be on the other side of the hill.
- ◆ Never attempt to turn the ATV around on any hill until you have mastered the turning technique as described in the Owner's Manual on level ground. Be very carefully when turning on any hill.
- ◆ Avoid crossing the side of a steep hill if possible. When crossing the side of a hill, shift your weight to the uphill side of the ATV.



Do not attempt to climb hills until you have mastered basic maneuvers on flat ground.

Always check the terrain carefully before attempting any hill. In all cases avoid inclines with slippery or loose surfaces or obstacles that might cause you to lose control.

To climb a hill, you need traction, momentum and steady throttle. For more traction and control for climbing steeper and/or rougher slopes, select the "4WD" or 4WD-LOCK. Travel fast enough to maintain momentum but not so fast that you cannot react to changes in the terrain as you climb.

It is important when climbing a hill to make sure that your weight is transferred forward on the ATV. This can be accomplished by leaning forward and on steeper inclines, standing on the footboards and leaning forward over the handlebars. Whenever possible, ride straight up hills.

Slow down when you reach the crest of the hill if you cannot see clearly what is on the other side there could be another person, an obstacle or a sharp drop off. Use common sense and remember that some hills are too steep for you to climb or descend.

If you are climbing a hill and you find that you have not properly judged your ability to make it to the top, you should turn the ATV around while you still have forward motion and go down the hill.

If your ATV has stalled or stopped and you believe you can continue up the hill, restart carefully to make sure you do not lift the front wheels which could cause you to lose control. If you are unable to continue up the hill, dismount the ATV on the uphill side. Physically turn the ATV around and then descend the hill.

If you start to roll back wards, DO NOT apply either brake abruptly. If you are in “2WD), apply only the front brake. When fully stopped, apply the rear brake as well and then shift to the park position. If you are in “4WD” because all wheels are interconnected by the drive train, applying either brake will brake all wheels, therefore avoid sudden application of either the front or rear brake as the wheels on the uphill side could come off the ground. The ATV could easily tip over backwards. Apply both the front and rear brakes gradually. When fully stopped, shift to the park position and dismount the ATV immediately on the uphill side or to a side if pointed straight uphill. Turn the ATV around and remount, following the procedure described in the Owner’s Manual.



**WARNING!**

Stalling, rolling backwards or improperly dismounting while climbing a hill could result in ATV overturning. If you cannot control the ATV, dismount immediately on the uphill side.

**RIDING DOWN HILL**



**WARNING!**

Going down a hill improperly could cause overturns or loss of control. Always follow proper procedures for going down hills as described in this Owner’s Manual.

- ◆ Always check the terrain carefully before you start down any hill.
- ◆ Never operate the ATV on hills too steep for the ATV or for your ability. The ATV can overturn more easily on extremely steep hills than on level surfaces or small hills.
- ◆ Shift your weight backward and to the upside of the hill.
- ◆ Never go down a hill at high speed.
- ◆ Avoid going down a hill at an angle that would cause the ATV to lean sharply to one side. Go straight down the hill where possible.
- ◆ Improper braking can cause the wheels on the hillside to come off the ground or cause loss of traction. Apply brakes gradually. If in “2WD”, apply only the rear brake.





When riding your ATV downhill, shift your weight as far to the rear and uphill side of the ATV as possible. Move back on the seat and sit with your arms straight. Engine compression will do most of the braking for you. For maximum engine compression braking effect, select the low gear position and change to “4WD” before beginning to descend the hill.

Use caution while descending a hill with loose or slippery surfaces. Braking ability and traction may be adversely affected by these surfaces. Improper braking may also cause a loss of traction.

When this ATV is in “4WD”, all wheels are interconnected by drive train. This means that applying either the front brake or the rear brake will brake all wheels. When descending hills, using either brake lever or the brake pedal will brake the wheels on the downhill side. Avoid sudden application of either the front or rear brake because the wheels on the uphill side could come off the ground. Apply both the front and rear brakes gradually.

Whenever possible, ride your ATV straight downhill. Avoid sharp angles, which could allow the ATV to tip or roll over. Carefully choose your path and ride no faster than you will be able to react to obstacles, which may appear.

## **CROSSING A SLOPE**



### **WARNING!**

Improperly crossing hills or turning on hills could cause loss of control or cause the ATV to overturn.

- ◆ Always follow proper procedures as described in the Owner’s Manual.
- ◆ Avoid hills with excessively slippery or loose surfaces.
- ◆ Avoid crossing the side of a steep hill.
- ◆ Shift your weight to the uphill side of the ATV.
- ◆ Never attempt to turn the ATV around on any hill until you have mastered the turning technique as described in the Owner’s Manual on level ground. Be very careful when turning on any hill.



Traversing a sloping surface on your ATV requires you to properly position your weight to maintain proper balance. Be sure that you have learned the basic riding skills on flat ground before attempting to cross a sloping surface. Avoid slopes with slippery surfaces or rough terrain that may upset your balance.

As you travel across a slope, lean your body in the uphill direction. It may be necessary to

correct the steering when riding on loose surfaces by pointing the front wheels slightly uphill. When riding on slopes, be sure not to make sharp turns either up or down hill. If your ATV does begin to tip over, gradually steer in the downhill direction if there are no obstacles in your path. As you regain proper balance, gradually steer again in the direction you wish to travel.

## **CROSSING THROUGH SHALLOW WATER**



### **WARNING!**

Operating this vehicle through deep or fast flowing water can lead to loss of control or an overturn. To reduce your risk of drowning or other injuries, use care when crossing through water. Never operate this ATV water deeper than the depth specified in your Owner's Manual, as tires may float, increase the risk of an overturn.

The ATV can be used to cross slow moving, shallow water of up to maximum of 35 cm (14 in) in depth. Before entering the water, choose your path carefully. Enter where there is no sharp drop off, and avoid rocks or other obstacles, which may be slippery or upset the ATV. Drive slowly and carefully.

Test your brakes after leaving the water. If necessary apply them several times to let the friction dry out the linings. Do not continue to ride your ATV without verifying that you have regained proper braking ability.



### **WARNING!**

Wet brakes may have reduced stopping ability, which could cause loss of control

After riding your ATV in water, be sure to drain the trapped water by removing the check hose at the bottom of the air filter case, remove the v-belt case drain bolt and front storage compartment drain plug to drain any water that may have accumulated.



### **NOTICE!**

Undrained water can cause damage or improper operation.

## **RIDING OVER ROUGH TERRAIN**



### **WARNING!**

Riding improperly over obstacles could cause loss of control or a collision. Before operating in a new area, check for obstacles. Never attempt to ride over large obstacles, such as large rocks or fallen trees. When you go over obstacles, always follow proper procedures as described in the Owner's Manual.

Riding over rough terrain should be done with caution. Look out for obstacles, which could cause damage to the ATV or could lead to an upset or accident. Be sure to keep your feet firmly mounted on the footboards at all times. Avoid jumping the ATV as loss of control and damage to the ATV may result.

## SLIDING AND SKIDDING



### WARNING!

Skidding or sliding improperly may cause you lose control of this ATV. You may also regain traction unexpectedly, which may cause the ATV to overturn.

- ◆ Learn to safety control skidding or sliding by practicing at low speeds and on level, smooth terrain.
- ◆ ON extremely slippery surfaces such as ice, go slowly and be very cautious in order to reduce the chance of skidding or sliding out of control.

Care should be used when riding on loose or slippery surfaces since the ATV may slide. If unexpected and uncorrected, sliding could lead to an accident.

To reduce the tendency for the front wheels to slide in loose or slippery conditions, positioning your weight over the front wheels will sometimes help.

If the rear wheels of your ATV start to slide sideways, control can usually be regained by steering in direction of the slide. Applying the brakes or accelerating is not recommended until you have corrected the slide.

With practice, over a period of time, skill at controlled sliding can be developed. The terrain should be chosen carefully before attempting such maneuvers since both stability and control are reduced. Bear in mind that sliding maneuvers should always be avoided on extremely slippery surfaces such as ice since all control may be lost.

## WHAT TO DO

- If your ATV doesn't turn when you want it to:  
Bring ATV to a stop and practice the turning maneuvers again. Be sure you are putting your weight on the footboard to the outside of the turn. Position your weight over the front wheels for better control
- If your ATV begins to tip while turning:  
Lean more into the turn to regain balance. If necessary, gradually let off the throttle and / or steer to the outside of the turn.
- If your ATV starts to slide sideways:  
Steer in direction of the slide if you have the room. Applying the brakes or accelerating is not recommended until you have corrected the slide.
- If your ATV can't make it up a hill you are trying to climb:  
Turn the ATV around if you still have forward speed. If not, stop, dismount on the uphill side of the ATV and physically turn the ATV around. If the ATV starts to slip backwards, **DO NOT USE THE REAR BRAKE IF THE ATV IS IN "2WD"**- The ATV may tip over on top of you. Dismount the ATV on the uphill side.
- If your ATV is traversing a sloping surface:  
Be sure to ride with your weight positioned towards the uphill side of the ATV to Maintain proper balance. If the ATV starts to tip, steer down the hill to regain balance. If you discover that the ATV is going to tip over, dismount on the uphill side.
- If your ATV encounters shallow water:  
Ride slowly and carefully through slow moving water, watching for obstacles. Be sure to let water drain from the ATV and **CHECK YOUR BRAKES FOR PROPER OPERATION** when you come out of the water. **DO not** continue to ride your ATV until you have regained adequate braking ability.

## PERIODIC MAINTENANCE

NO.	ITEM	Check or maintenance job	Whichever comes first	INITIAL		EVERY		
				MONTH	1	3	6	12
				Km	200	1000	2000	4000
				Mi	120	600	1200	2400
1	Exhaust system	♦ Check for leakage and replace gasket if necessary		T	T	T	T	
		♦ Check for looseness and tighten all screw clamps and joints if necessary						
2	Valves	♦ Check valve clearance and adjust if necessary		I		I	I	
3	Air filter element	♦ Clean and replace if necessary			I	I	I	
4	Spark plug	♦ Check condition and clean, re-gap or replace if necessary				I	I	
5	Engine oil	♦ Change ♦ Check ATV for oil leakage and correct if necessary		R		R	R	
6	Engine oil filter	♦ Replace		R		R	R	
7	Engine oil strainer	♦ Clean		I		I	I	
8	Gear Box Oil	♦ Replace		R		R	R	
9	Front Differential gear oil	♦ Change ♦ Check ATV for oil leakage and correct if necessary		R		R	R	
		Replace every 4 years						
10	Rear Differential gear oil	♦ Change ♦ Check ATV for oil leakage and correct if necessary		R		R	R	
		Replace every 4 years						
11	Fuel line	♦ Check fuel hoses for cracks or other damage and replace if necessary				I	I	
12	Fuel filter	♦ Replace		Every 2 years				
13	Front brake	♦ Check operation and correct if necessary ♦ Check fluid level and ATV for fluid leakage and correct if necessary		I	I	I	I	
		♦ Replace brake pads		Whenever worn to the limit				
14	Rear brake	♦ Check operation and correct if necessary ♦ Check the brake lever and pedal free play and adjust if necessary		I	I	I	I	
		♦ Check brake friction plate wear and replace if necessary		I	I	I	I	
15	Brake hoses	♦ Check for cracks or other damage and replace if necessary			I	I	I	
		♦ Replace		Every 4 years				

16	Wheels	♦ Check run out and for damage and replace if necessary	I		I	I
17	Tires	♦ Check tread depth and for damage and replace if necessary ♦ Check air pressure and balance and correct it if necessary		I	I	I
18	Wheel hub bearings	♦ Check for looseness or damage and replace if necessary	I		I	I
19	V-belt	♦ Check for wear, cracks or other damage and replace if necessary			I	I
20	Drive shaft universal joint	♦ Lubricate with grease			L	L
21	Chassis fasteners	♦ Make sure that all nuts, bolts and screws are properly tightened	T	T	T	T
22	Shock absorber assemblies	♦ Check operation and correct if necessary ♦ Check for oil leakage and replace if necessary			I	I
23	Rear knuckle pivots	♦ Lubricate with grease			L	L
24	Steering shaft	♦ Lubricate with grease			L	L
25	Steering system	♦ Check operation and repair or replace if damaged ♦ Check toe-in and adjust if necessary	I	I	I	I
26	Engine mount	♦ Check for the cracks or other damage and replace if necessary			I	I
27	Transmission boots	♦ Check for the cracks or other damage and replace if necessary	I	I	I	I

L: Lubricate

C: Clean

R: Replace

T: Tighten

I: Inspection, cleaning and adjustment

Have your ATV serviced and checked by an authorized TGB dealer. Ensure the service book is stamped and signed.

Failure to do so could invalidate your warranty.

The maintenance schedule is established by taking the monthly kilometer as a reference which ever comes first.

Periodic inspection, adjustment and lubrication will keep your vehicle in the safest and most efficient condition possible. Safety is an obligation of the vehicle owner/operator.



### WARNING!

Failure to properly maintain the vehicle or performing maintenance activities incorrectly may increase your risk of injury or death during service or while using the vehicle. If you are not familiar with vehicle service, have a TGB dealer perform the service.

**WARNING!**

Turn off the engine when performing maintenance unless otherwise specified. A running engine has moving parts that can catch on body parts or clothing and electrical parts that can cause shocks or fires. Running the engine while servicing can lead to eye injury, burns, fire or carbon monoxide poisoning-possibly leading to death.

**WARNING!**

Brake discs, calipers, drums and linings can become very hot during use. To avoid possible burns. Let brake components cool before touching them.

The intervals given in the periodic maintenance charts should be considered as a general guide under normal riding conditions. However, ***depending on the weather, terrain, geographical location and individual use. The maintenance intervals may need to be shortened.***

**CAUTION!**

Some maintenance items need more frequent service if you are riding in unusually wet, sandy or muddy areas or at full throttle.

- Hydraulic brake service

Regularly check and if necessary correct the brake fluid level.

Every two years replace the internal components of the brake master cylinder and calipers and change the brake fluid.

- Replace the brake hoses every four years and if cracked or damaged.
- Remove the carbon deposits in cylinder head, piston and exhaust system when power is obviously lower than normal.
- Perform maintenance and check when continuous abnormal misfire, after burn and overheating occur.

## CLEANING AND STORAGE

### Cleaning

Frequent, through cleaning of your ATV will not only enhance its appearance but will improve its general performance and extend the useful life of many components.

1. Before cleaning the ATV:
  - a. Block off the end of the exhaust pipe to prevent water entry. A plastic bag and strong rubber band may be used.
  - b. Make sure the spark plug and all filler caps are properly installed.
2. If the engine case is excessively greasy, apply degreaser with a paintbrush. Do not apply degreaser to wheel axles.
3. Rinse the dirt and degreaser off with a garden hose. Use only enough pressure to do the job.



#### **WARNING!**

- ◆ Wet brakes may have reduced stopping ability, increasing the chance of an accident. Test the brakes after washing. Apply the brakes several times at slow speeds to let friction dry out the linings.
- ◆ Excessive water pressure may cause water seepage and deterioration of wheel bearing, brakes, transmission seals and electrical devices. Many expensive repair bills have resulted from improper high-pressure detergent applications such as those available in coin-operated car washers.

4. Once most of the dirt has been hosed off, wash all surfaces with warm water and mild, detergent-type soap. AN old toothbrush or bottlebrush is handy for hand to reach places.
5. Rinse the ATV of immediately with clean water and dry all surfaces with a chamois, clean towel or soft absorbing cloth.
6. Clean the seat with vinyl upholstery cleaner to keep the cover pliable and glossy.
7. Automotive type wax may be applied to all painted and chrome plated surfaces. Avoid combination cleaner-waxes. Many contain abrasives, which may mar the paint or protective finish. When finished cleaning, start the engine and let it idle for several minutes.

### Storage

#### **Short-term**

Always store your ATV in a cool, dry place and if necessary, protect it against dust with a porous cover.



#### **WARNING!**

Storing the ATV in a poorly ventilated room or covering it with a tarp while it is still wet, will allow water and humidity to seep in and cause rust. To prevent corrosion, avoid damp cellars, stables and area where strong chemicals are stored

## Long-term

Before storing your ATV for several months:

1. Follow all the instructions in the “Cleaning” section of this chapter.
2. Turn the fuel cock lever to “OFF”.
3. Drain the carburetor float chamber by loosening the drain bolt; this will prevent fuel deposits from building up. Pour the drained fuel into the fuel tank.
4. Fill up the fuel tank and add fuel stabilizer (if available) to prevent the fuel from deteriorating.
5. Perform the following steps to protect the cylinder, piston rings, etc. from corrosion.
  - a. Remove the spark plug cap and spark plug.
  - b. Pour a teaspoonful of engine oil into the spark plug bore.
  - c. Install the spark plug cap onto the spark plug and then place the spark plug on the cylinder head so that the electrodes are grounded.
  - d. Turn the engine over several times with the starter.
  - e. Remove the spark plug cap from the spark plug and then install the spark plug and the spark plug cap.
6. Lubricate all control cables and the pivoting points of all levers and pedals.
7. Check and if necessary, correct the tire air pressure and then block up the ATV so that all of its wheels are off the ground. Alternatively, turn the wheels a little every month in order to prevent the tires from becoming degraded in one spot.
8. Cover the muffler outlet with a plastic bag to prevent moisture from entering it.
9. Remove the battery and fully charge it. Store it in a cool, dry place and charge it once a month. Do not store the battery in an excessively cold or warm place less than 0°C or more than 30°C.
10. Make necessary repairs before storing the ATV.



## TROUBLESHOOTING

Contact your dealer for service if you're unable to identify solutions using the following charts.

### Engine doesn't turn over

Possible cause	Solution
Tripped circuit breaker	Reset the breaker
Low battery voltage	Recharge battery to 12.5 VDC
Loose battery connections	Check all connections and ignition
Loose solenoid connections	Check all connections and ignition

### Engine turns over but fails to start

Possible cause	Solution
Out of fuel	Refuel
Clogged fuel filter	Inspect and clean or replace
Water is present in fuel	Drain the fuel system and refuel
Fouled or defective spark plug	Inspect plug, replace if necessary
Crankcase filled with water or fuel	Immediately see your dealer
Clogged fuel filter	Replace the filter
Low battery voltage	Recharge battery to 12.5 VDC
Mechanical failure	See your dealer

### Engine pins or knocks

Possible cause	Solution
Poor quality or low octane fuel	Replace with recommended fuel
Incorrect ignition timing	See your dealer
Incorrect spark plug gap or heat range	Set gap to specs or replace plugs

### Engine backfires

Possible cause	Solution
Weak spark from spark plugs	Inspect, clean and/or replace spark plugs
Incorrect spark plug gap or heat range	Set gap to specs or replace plugs
Old or non-recommended fuel	Replace with new fuel
Incorrectly installed spark plug wires	See your dealer
Incorrect ignition timing	See your dealer
Mechanical failure	See your dealer

### Engine run irregularly, stalls or misfires

Possible weak spark cause	Solution
Fouled or defective spark plugs	Inspect, clean and/or replace spark plugs
Worn or defective spark plug wires	See your dealer
Incorrect spark plug gap or heat range	Set gap to specs or replace plugs
Loose ignition connections	Check all connections and tighten
Water present in fuel	Replace with new fuel
Low battery voltage	Recharge battery to 12.5 VDC
Kinked or plugged fuel vent line	Inspect and replace
Incorrect fuel	Replace with recommended fuel
Clogged air filter	Inspect and clean or replace
Reverse speed limiter malfunction	See your dealer
Electronic throttle control malfunction	See your dealer

Other mechanical failure	See your dealer
<b>Possible lean mixture fuel cause</b>	<b>Solution</b>
Low or contaminated fuel	Add or change fuel, clean the fuel system
Low octane fuel	Replace with recommended fuel
Clogged fuel filter	Replace filter
Incorrect jetting	See your dealer
<b>Possible rich mixture fuel cause</b>	<b>Solution</b>
Overuse of choke	Inspect, clean and/or replace spark plugs
Fuel is very high octane	Replace with lower octane fuel
Incorrect jetting	See your dealer

### Engine stops or loses power

<b>Possible cause</b>	<b>Solution</b>
Out of fuel	Refuel
Kinked or plugged fuel vent line	Inspect and replace
Water present in fuel	Replace with new fuel
Overuse of choke	Inspect, clean and/or replace spark plugs
Fouled or defective spark plugs	Inspect, clean and/or replace spark plugs
Worn or defective spark plug wires	See your dealer
Incorrect spark plug gap or heat range	Set gap to specs or replace plugs
Loose ignition connections	Check all connections and tighten
Low battery voltage	Recharge battery to 12.5 VDC
Incorrect fuel	Replace with recommended fuel
Clogged air filter	Inspect and clean or replace
Reverse speed limiter malfunction	See your dealer
Electronic throttle control Malfunction	See your dealer
Other mechanical failure	See your dealer
Overheated engine	Clean radiator screen and core if equipped Clean engine exterior See your dealer

P.D.I. Date:  
Odometer reading:  
Dealer stamp:

1st Service Date:  
Odometer reading:  
Dealer stamp:

2nd Service Date:  
Odometer reading:  
Dealer stamp:

3rd Service Date:  
Odometer reading:  
Dealer stamp:

4th Service Date:  
Odometer reading:  
Dealer stamp:

5th Service Date:  
Odometer reading:  
Dealer stamp:

6th Service Date:  
Odometer reading:  
Dealer stamp:

7th Service Date:  
Odometer reading:  
Dealer stamp:

8<sup>th</sup> Service

Date:

Odometer reading:

Dealer stamp:

9th Service

Date:

Odometer reading:

Dealer stamp:

10th Service

Date:

Odometer reading:

Dealer stamp:

11th Service

Date:

Odometer reading:

Dealer stamp:

12th Service

Date:

Odometer reading:

Dealer stamp:

13th Service

Date:

Odometer reading:

Dealer stamp:

14th Service

Date:

Odometer reading:

Dealer stamp:

15th Service

Date:

Odometer reading:

Dealer stamp:

## CONSUMER INFORMATION IDENTIFICATION NUMBER

Record the key identification number, vehicle identification number and model label information in the spaces provided below for assistance when ordering spare parts from TGB dealer or for reference in case the ATV is stolen.

### KEY IDENTIFICATION NUMBER:

\_\_\_\_\_

### VEHICLE IDENTIFICATION (FRAME) NUMBER:

\_\_\_\_\_

### KEY IDENTIFICATION NUMBER

The key identification number is stamped into the key. Record this number in the space provided and uses it for reference when ordering a new key.



Vehicle identification (frame) number is stamped into the frame  
The vehicle identification number is used to identify your ATV.

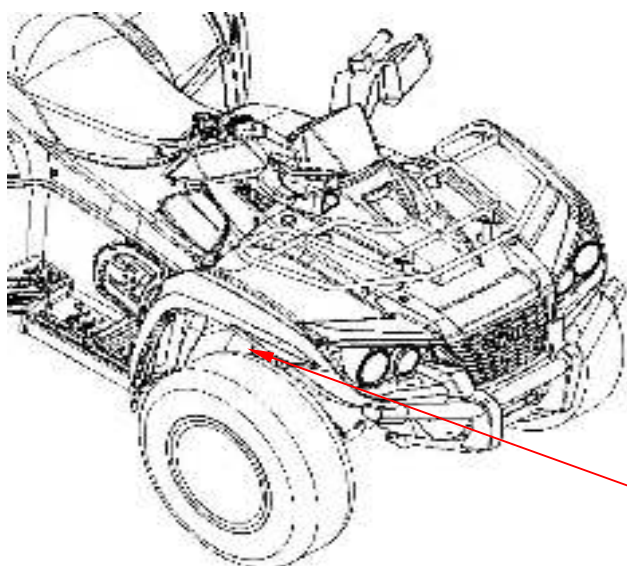

Official Distributor:



**ASP Group s.r.o.**

Adresa: Staroplzenecka 290, 326 00, Letkov, Czech Republic

Tel.: +420 378 21 21 21 E-mail: [info@aspgroup.cz](mailto:info@aspgroup.cz) Web: [www.aspgroup.eu](http://www.aspgroup.eu)